

iX (I20)

09/21 →



Please note that the function is restricted in vehicles equipped with Driving Assistant Professional. See Fig 12.

D

Produktübersicht
Elektro-Einbausatz für Anhängerkupplung / 13-polig / 12 Volt / ISO 11446

GB

Product overview
Electric wiring kit for towbars / 13-pin / 12 Volt / ISO 11446

F

Aperçu des produits
Faisceau pour attelage / 13 broches / 12 Volt / ISO 11446

I

Cerrellata dei prodotti
Cablaggio elettrico per ganci di traino / 13 poli / 12 Volt / ISO 11446

E

Descripción del producto
Kits eléctricos para enganches de remolques / 13 pins / 12 Volt / ISO 11446

NL

Productoverzicht
Elektro-inbouwset voor aanhangerkoppeling / 13-polig / 12 Volt / ISO 11446

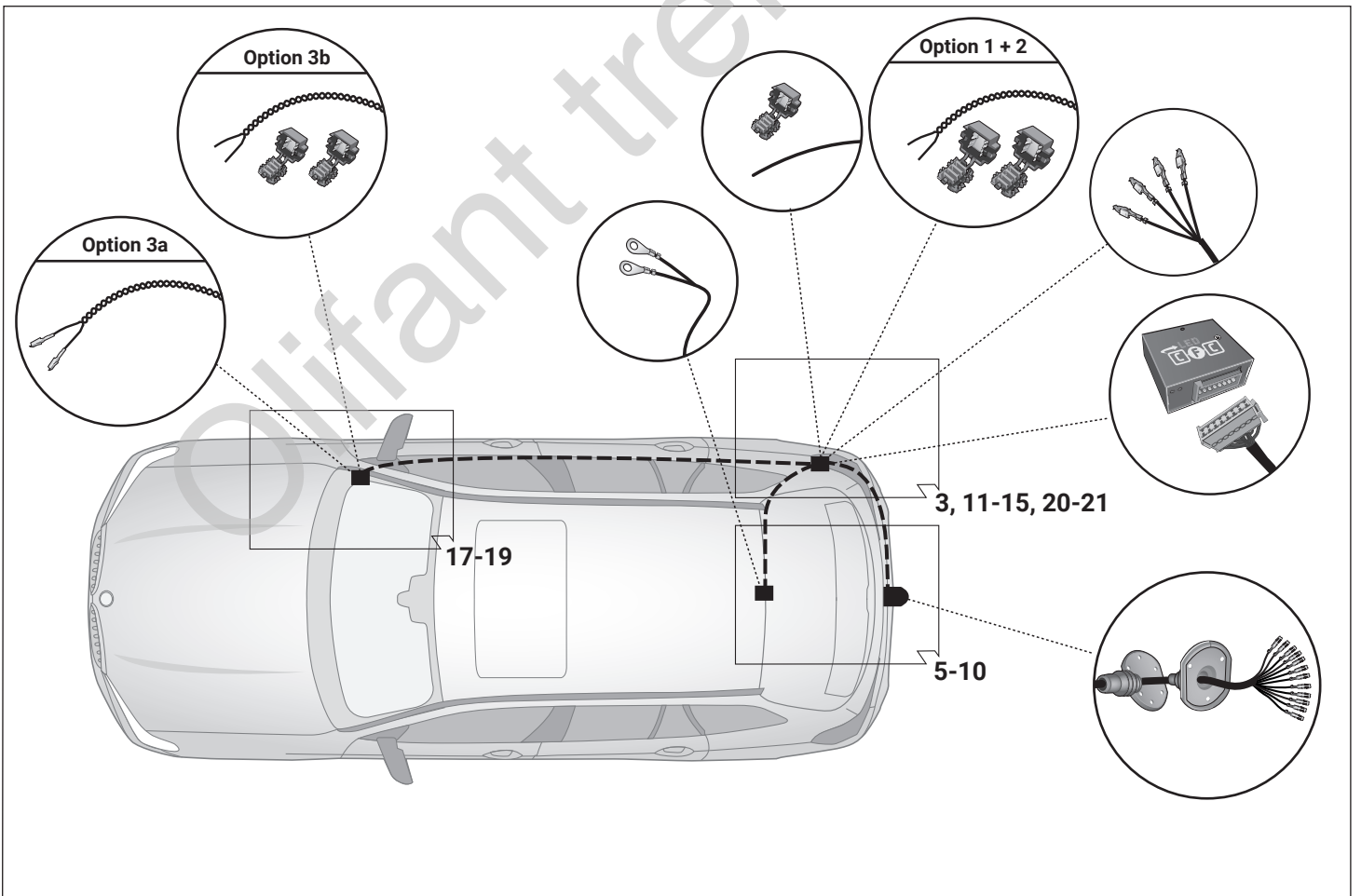
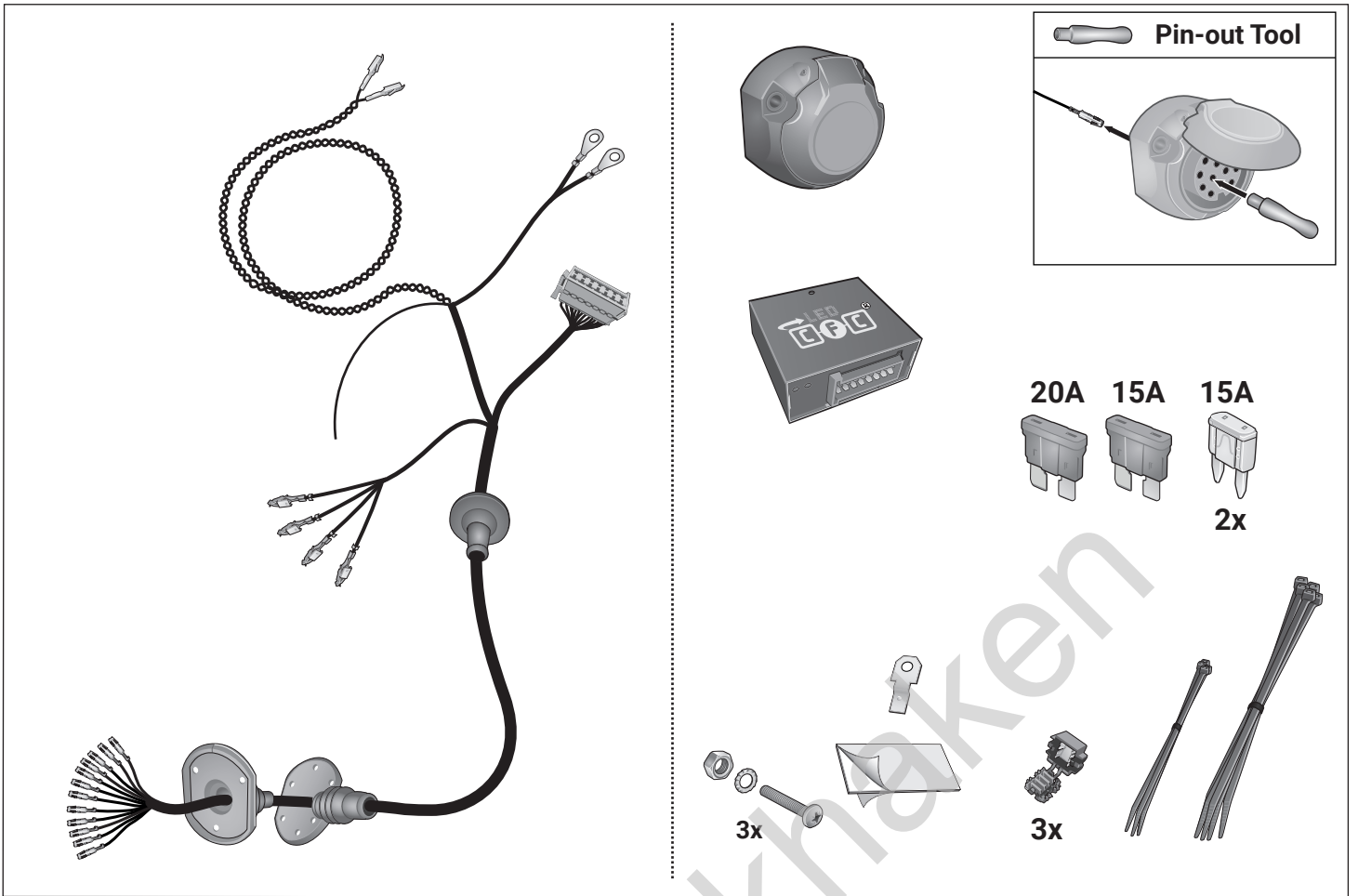

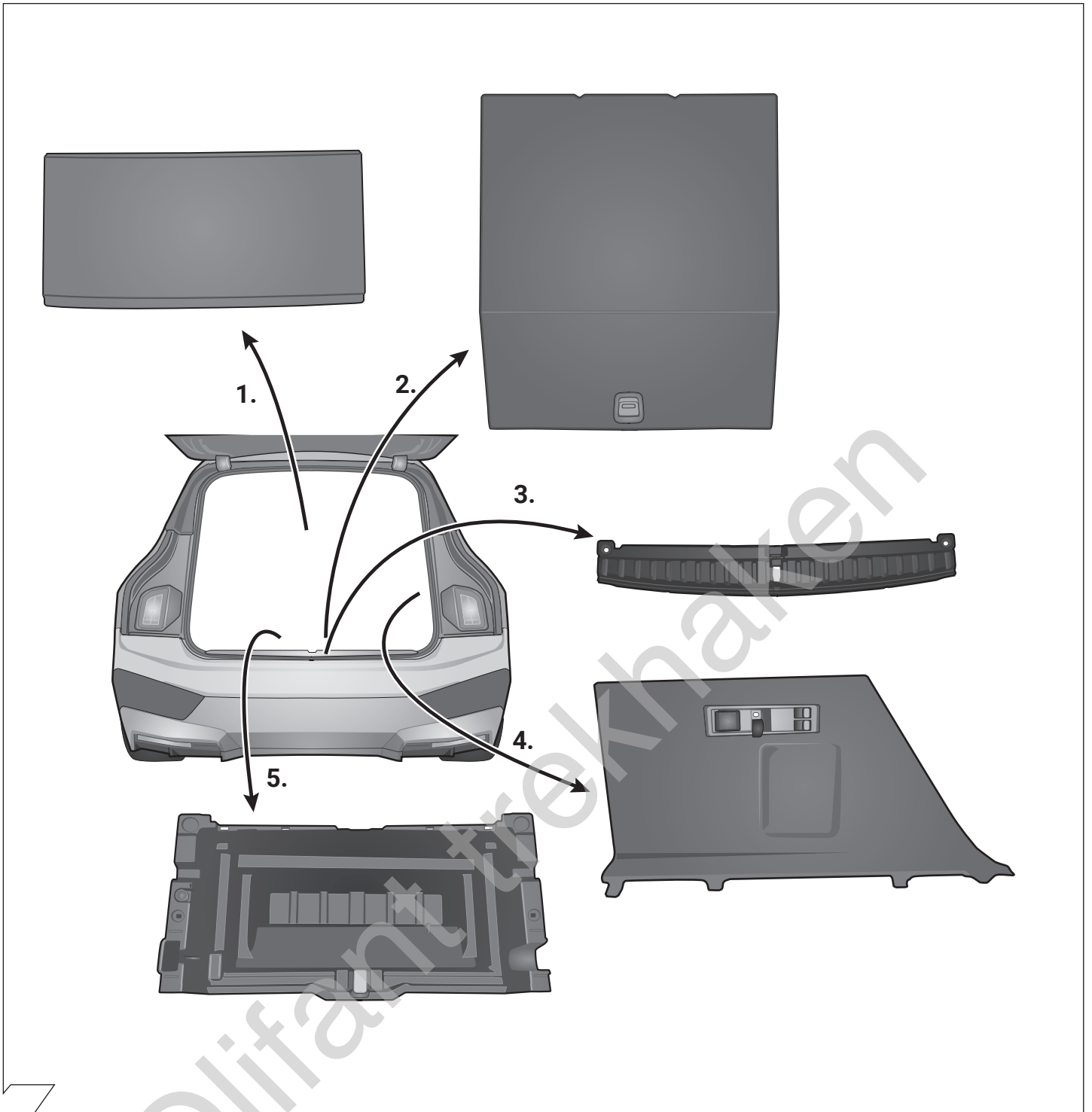

2

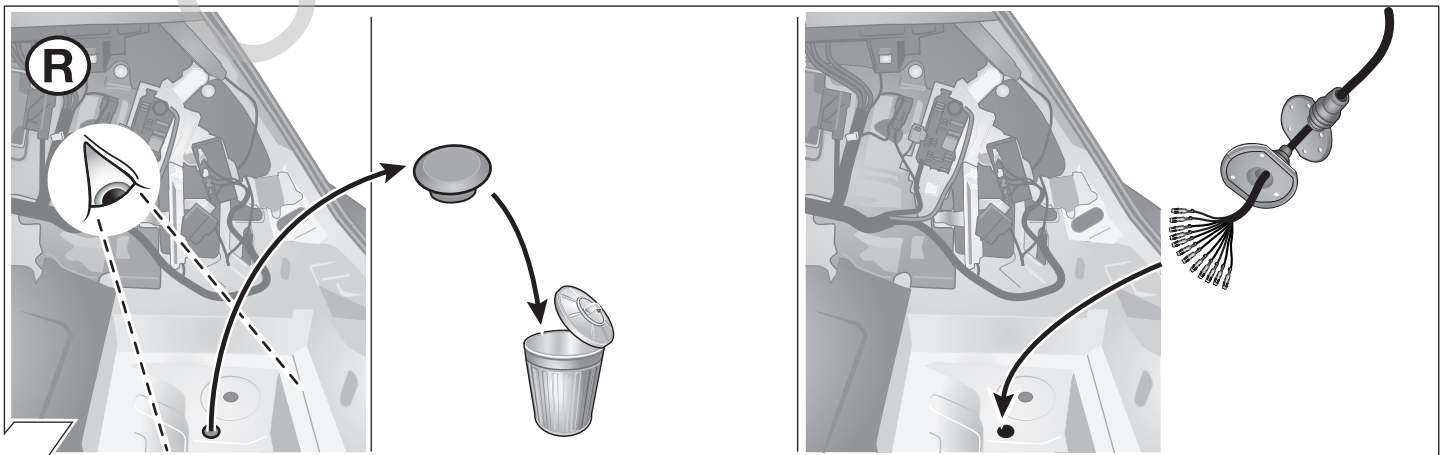

3

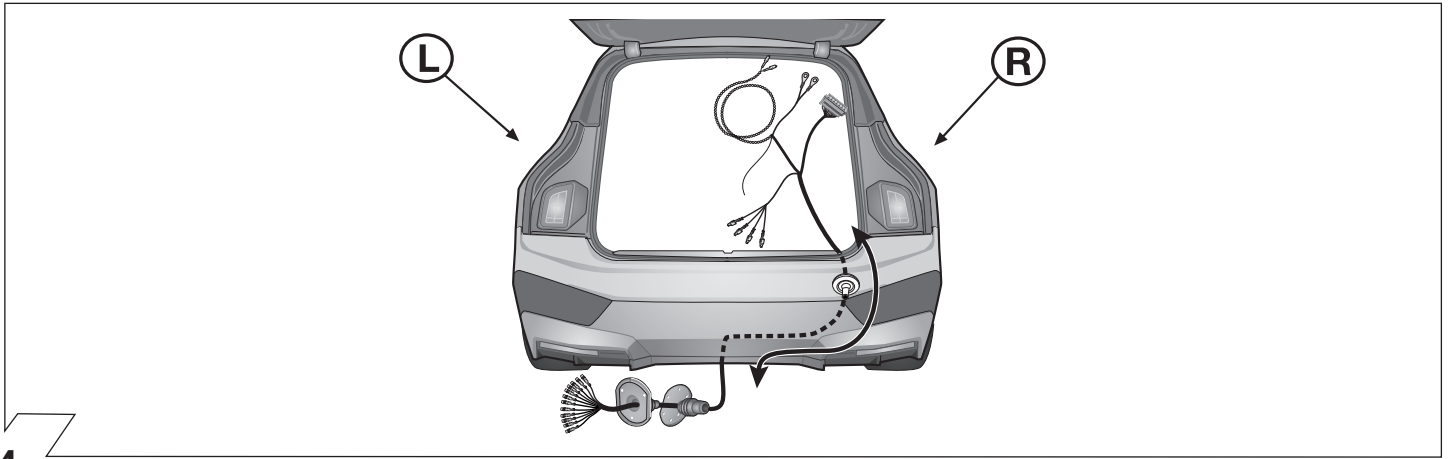

4

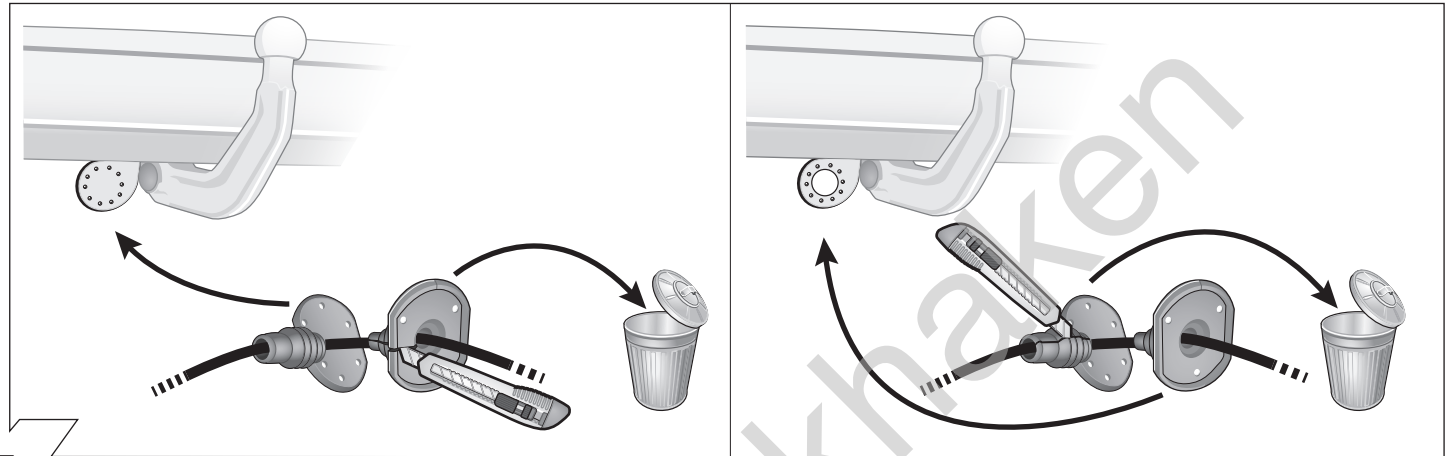

5

	GB	D	E	F	I	P	NL	DK	N	S	FIN	CZ	H	PL
BK	Black	Schwarz	Negro	Noir	Nero	Preto	Zwart	Sort	Svart	Svart	Musta	Černá	Fekete	Czarny
RD	Red	Rot	Rojo	Rouge	Rosso	Vermelho	Rood	Rød	Rød	Röd	Punainen	Červená	Piros	Czerwony
GN	Green	Grün	Verde	Vert	Verde	Verde	Groen	Grøn	Grønt	Grön	Vihreä	Zelená	Zöld	Zielony
OR	Orange	Orange	Naranja	Orange	Arancione	Laranja	Oranje	Orange	Orange	Orange	Oranssi	Oranzová	Narancs	Pomarańczowy
VT	Violet	Violett	Violeta	Violet	Viola	Violeta	Violet	Violet	Fiolett	Violett	Violetti	Fialová	Ibolya	Fioletowy
PK	Pink	Pink	Pink	Rose	Rosa	Cor-de-Rosa	Paars	Pink	Pink	Rosa	Pinkki	Růžová	Rózsaszín	Różowy
BL	Blue	Blau	Azul	Bleu	Blu	Azul	Blauw	Blå	Blátt	Blå	Sininen	Modrá	Kék	Niebieski
YL	Yellow	Gelb	Amarillo	Jaune	Giallo	Amarelo	Geel	Gul	Gult	Gul	Keltainen	Zlutá	Sárga	Żółty
WT	White	Weiss	Blanco	Blanc	Bianco	Branco	Wit	Hvid	Hvitt	Vt	Valkoinen	Bílá	Fehér	Biały
BR	Brown	Braun	Marrón	Brun	Marrone	Marrom	Bruin	Brun	Brunt	Brun	Ruskea	Hnědá	Barna	Brazowy
GY	Grey	Grau	Gris	Gris	Grigio	Cinzeno	Grijs	Grå	Grátt	Grå	Harmaa	Sedá	Szürke	Szary

6

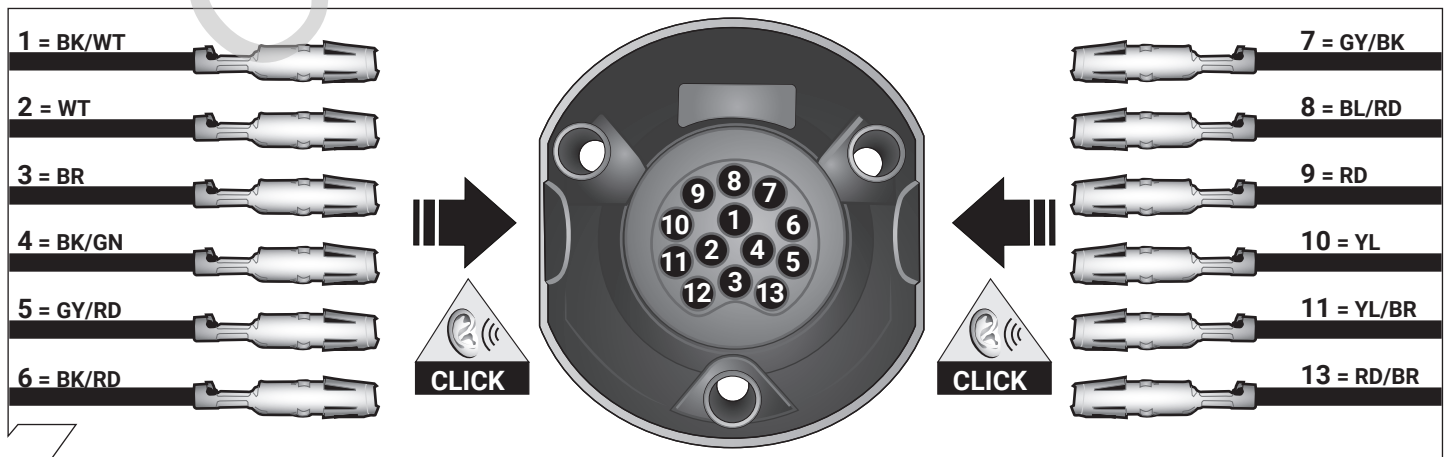

7

ISO 11446				
Belegung der Steckdose / Maximale Ausgangsleistung Socket configuration / Maximum power output Correspondance des contacts de la prise / Puissance de sortie maximale Abbinamento della presa / Uscita di alimentazione massima Indeling van de stekkerdoos / maximaal uitgangsvermogen				
	1/L	BK/WT	21W	
	2	WT	42W	
	3/31	BR		
	4/R	BK/GN	21W	
	5/58-R	GY/RD	52W	
	6/54	BK/RD	63W	
	7/58-L	GY/BK	52W	
	8	BL/RD	42W	
	9	RD	240W	
	10	YL	180W	
	11	YL/BR		
	12			
	13	RD/BR		

8

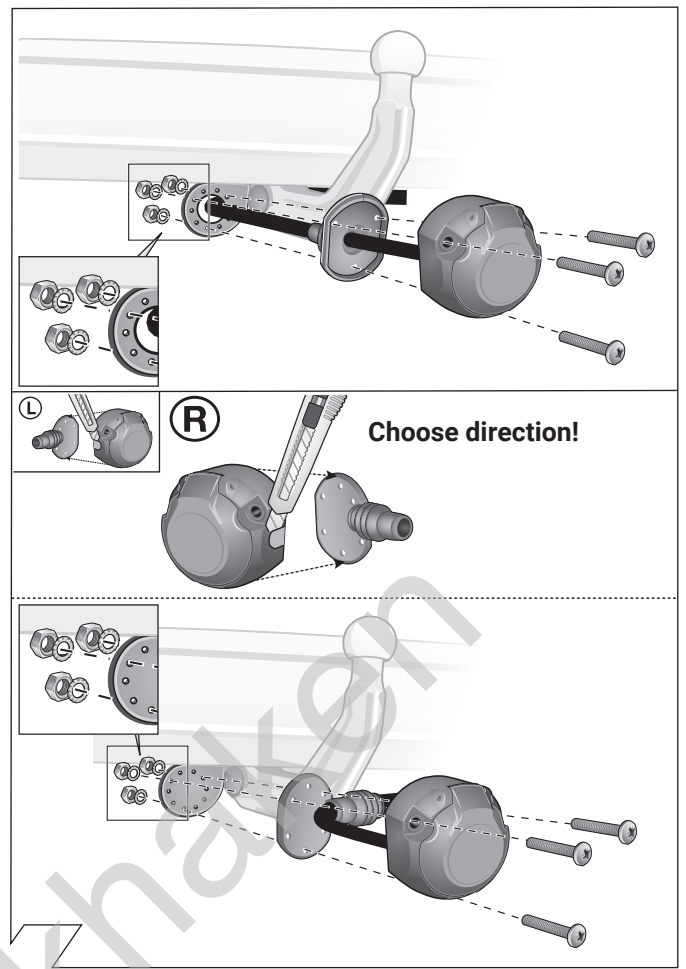

9

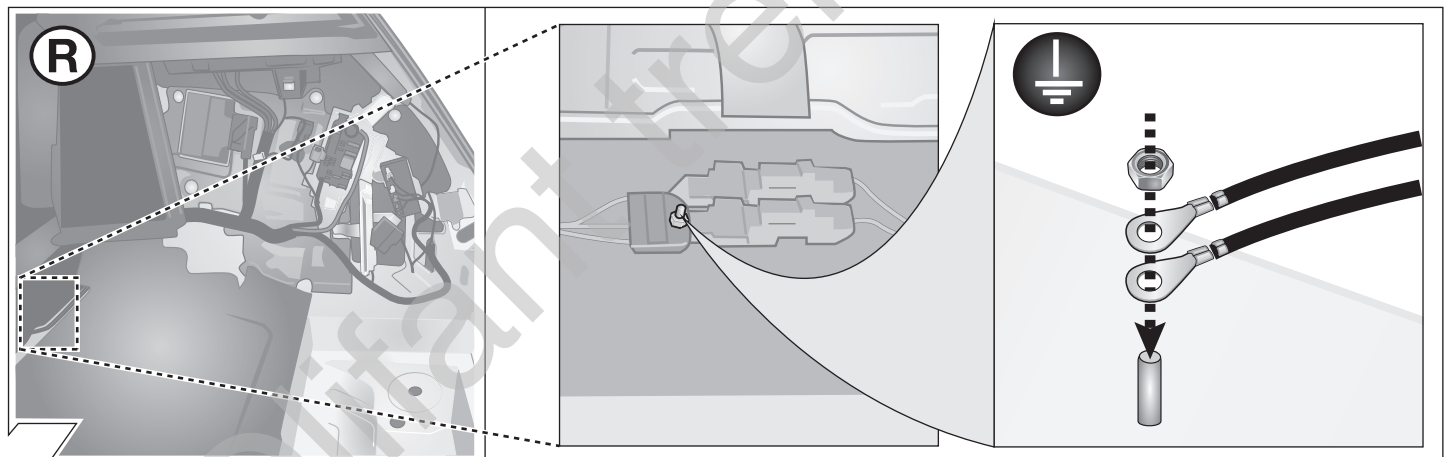

10

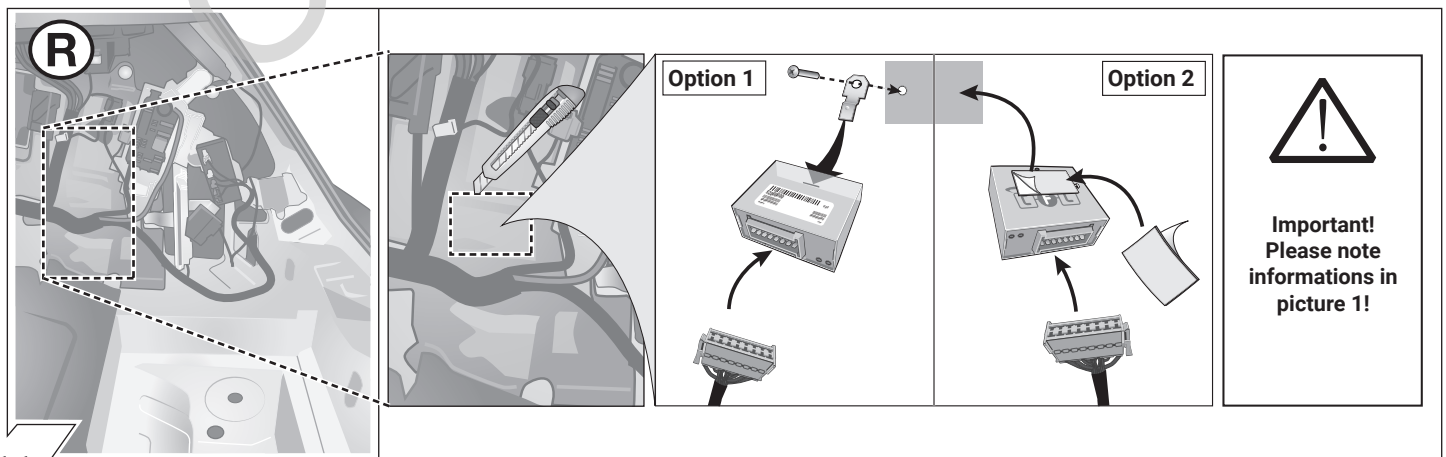

11

GB With equipment code S5AUA/05AU Driving Assistant Professional
F Avec code d'équipement S5AUA/05AU Driving Assistant Professional
E Con código de equipo S5AUA/05AU Driving Assistant Professional
PL Z kodem wyposażenia S5AUA/05AU Driving Assistant Professional

D Mit Ausstattungscodex S5AUA/05AU Driving Assistant Professional
I Con codice equipaggiamento S5AUA/05AU Driving Assistant Professional
NL Met uitrustingscode S5AUA/05AU Driving Assistant Professional
SK S kódem výbavy S5AUA/05AU Driving Assistant Professional



Pin 11 and Pin 2 disconnected

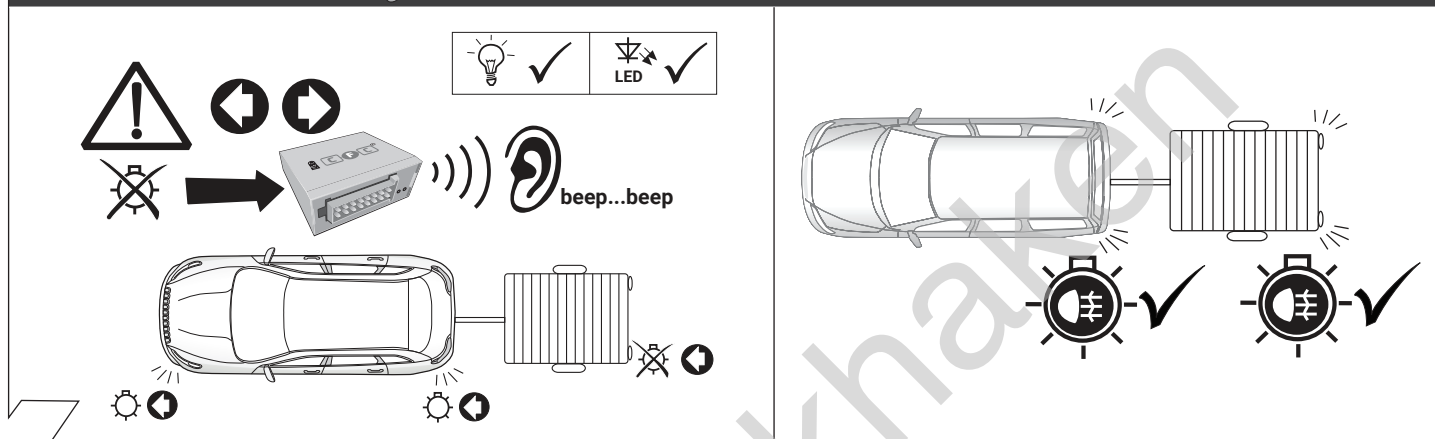

12

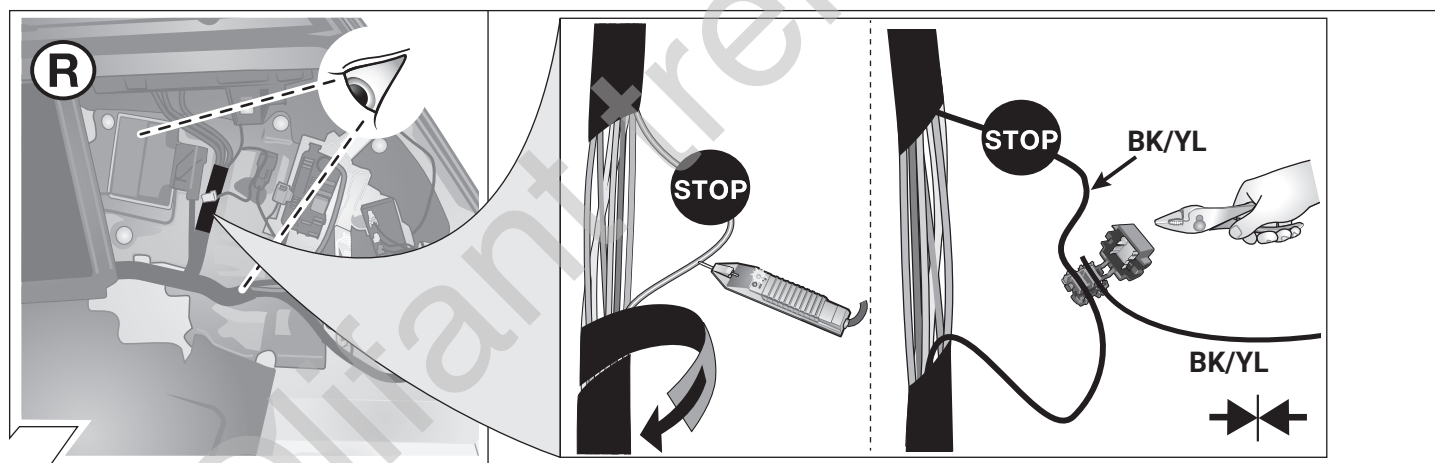

13

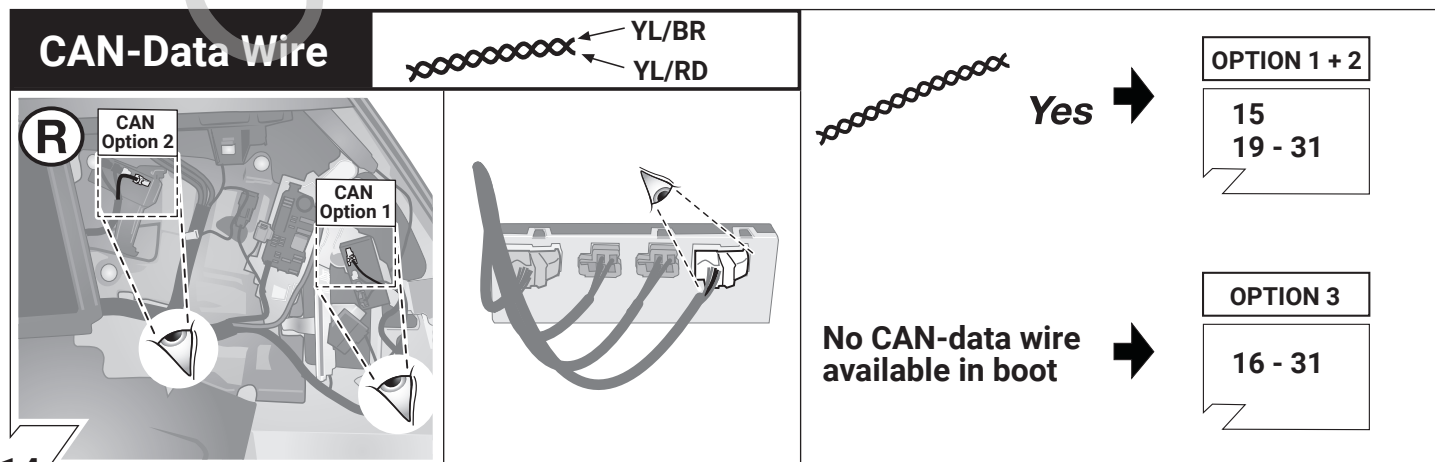

CAN-Data Wire

YL/BR
YL/RD



Yes →

OPTION 1 + 2

15
19 - 31

No CAN-data wire available in boot →

OPTION 3

16 - 31

14

OPTION 1 + 2

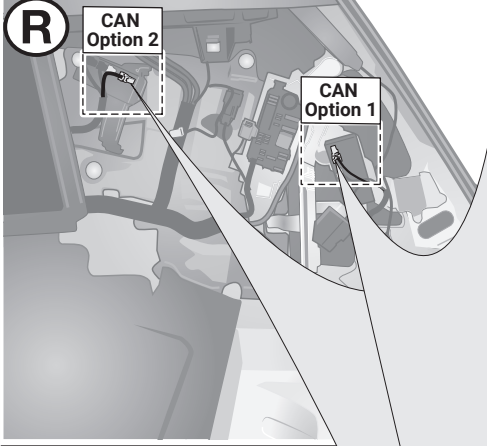

CAN-Data Wire

YL/BR (Pin 13)
YL/RD (Pin 14)

Important!
Please note informations in picture 1!

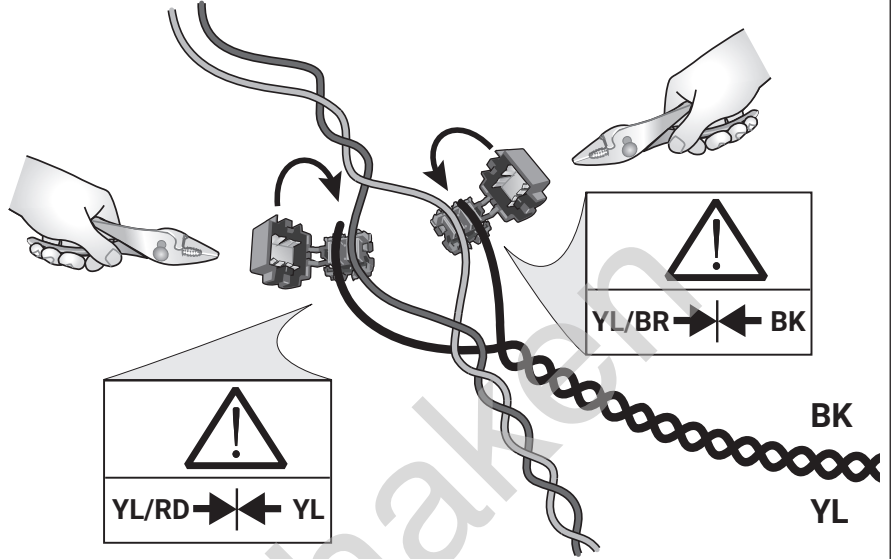

15

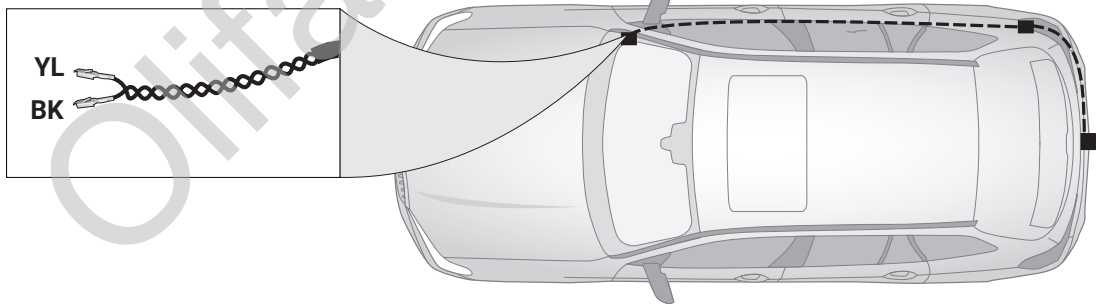

16

OPTION 3

a

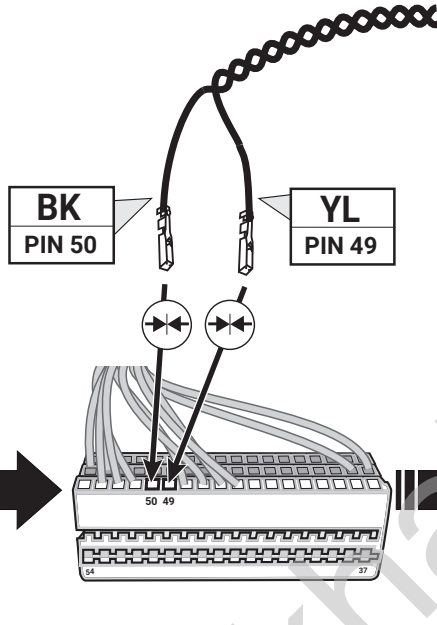
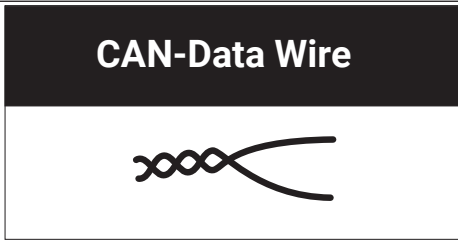
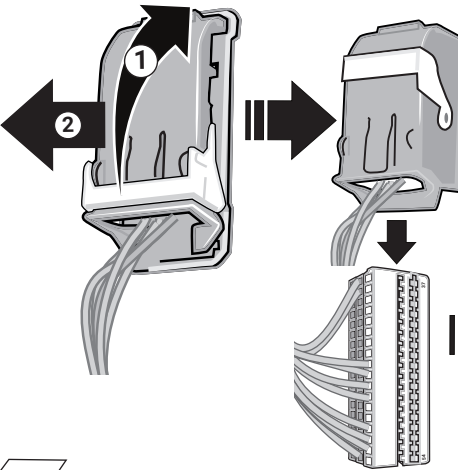
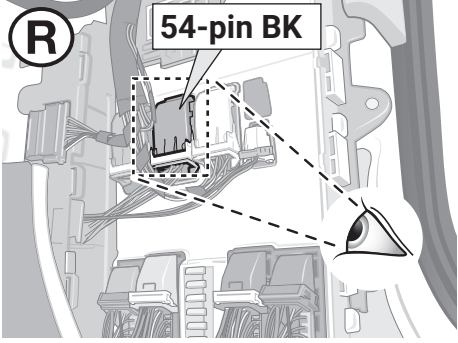

Important!
Please note informations in picture 1!



17

OPTION 3

b

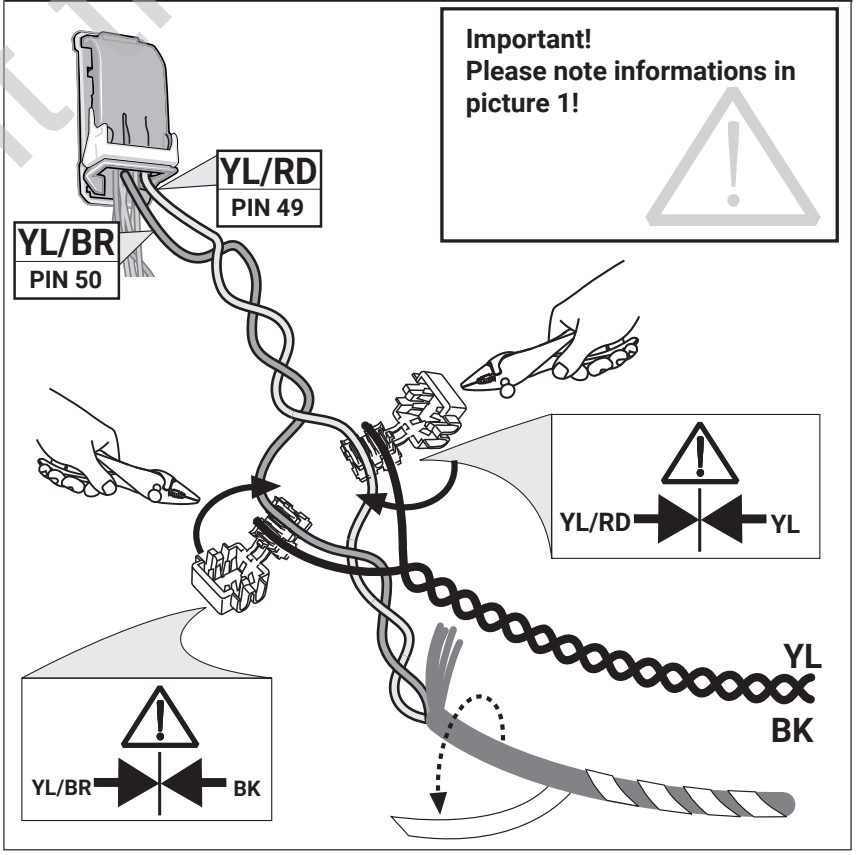
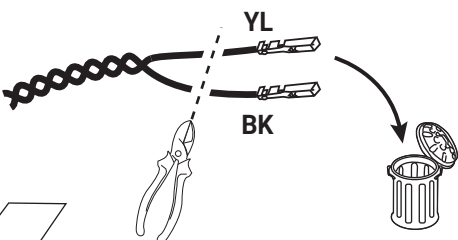
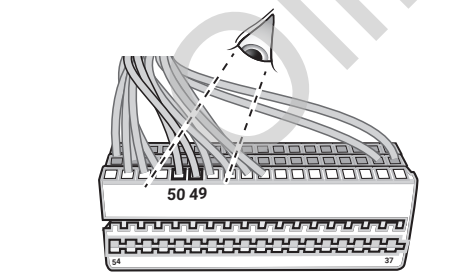
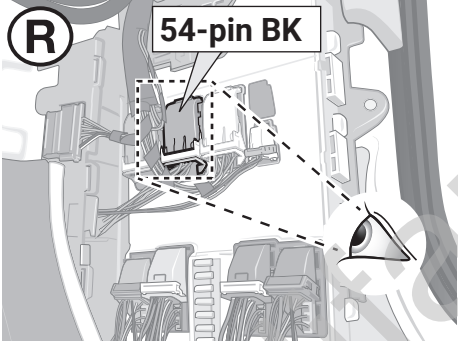

Important!
Please note informations in picture 1!

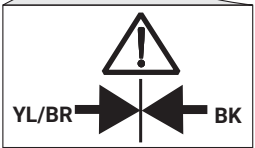
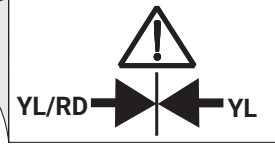

18

If present !

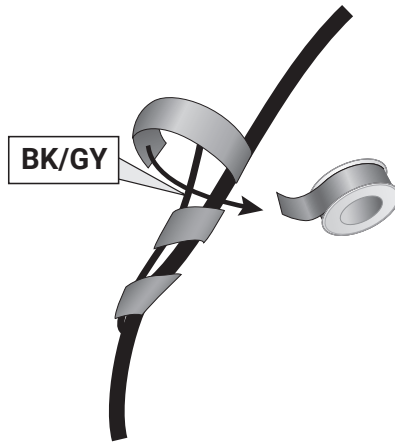

19

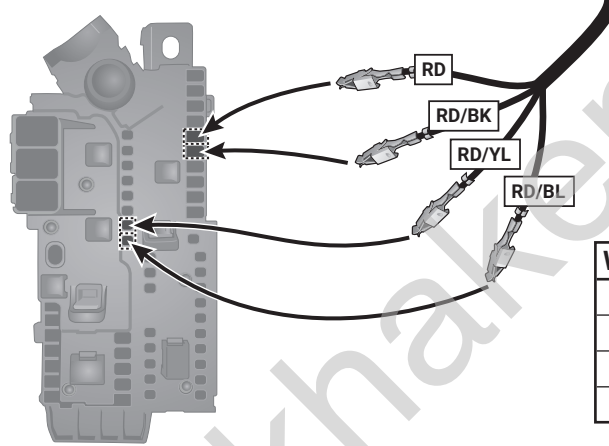
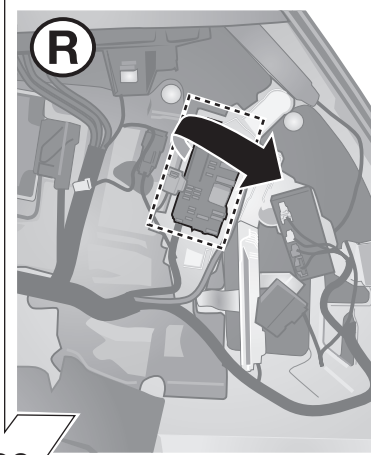

Wire colour	Position
RD	→ F25
RD/BK	→ F26
RD/YL	→ F37
RD/BL	→ F38

20

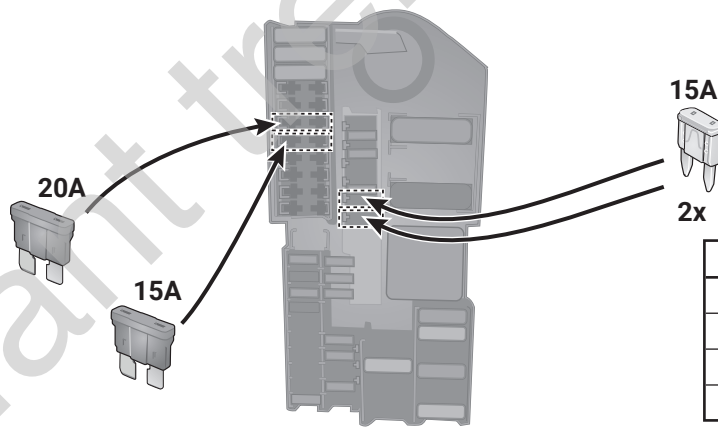

Fuse	Position
20A	→ F25
15A	→ F26
15A	→ F37
15A	→ F38

21

With factory fitted PDC

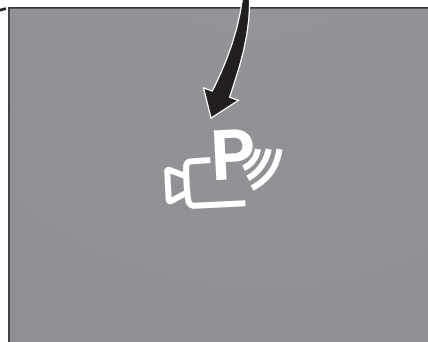
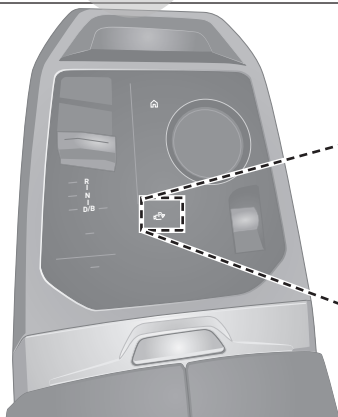

22

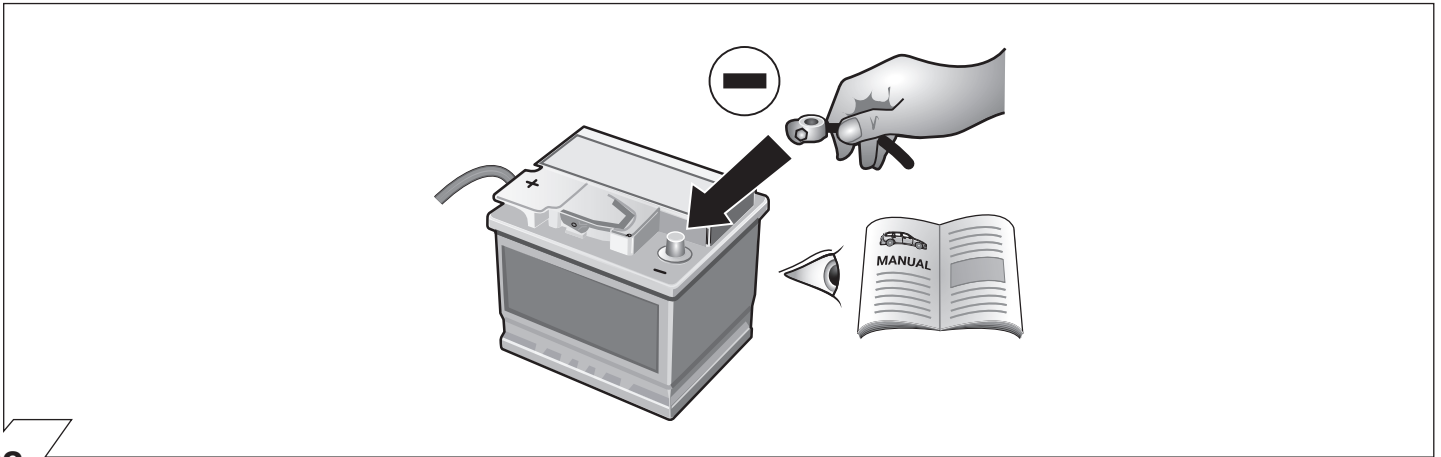

23

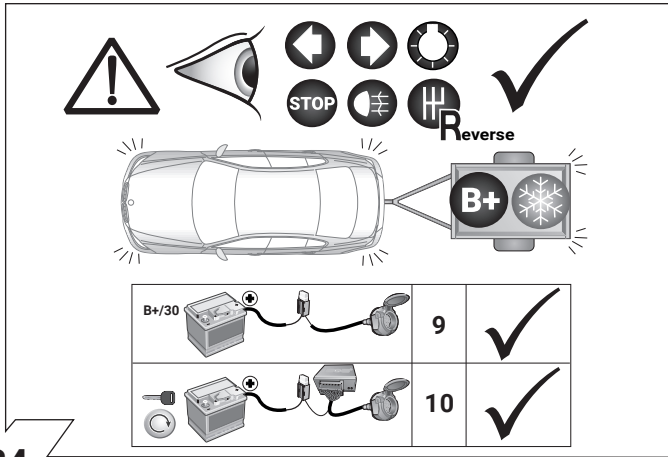

24



25

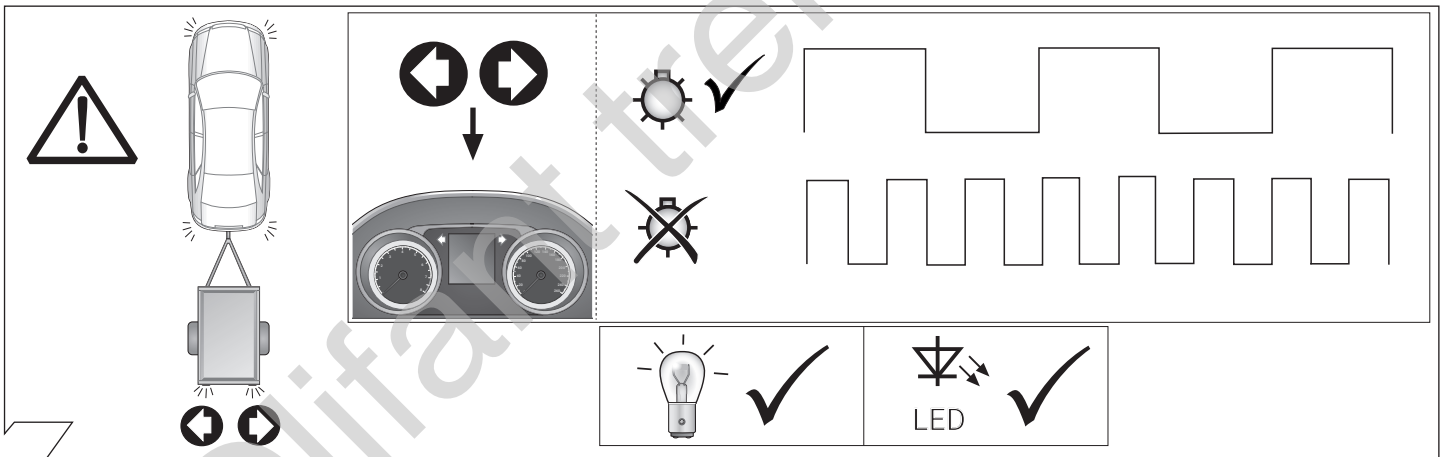

26

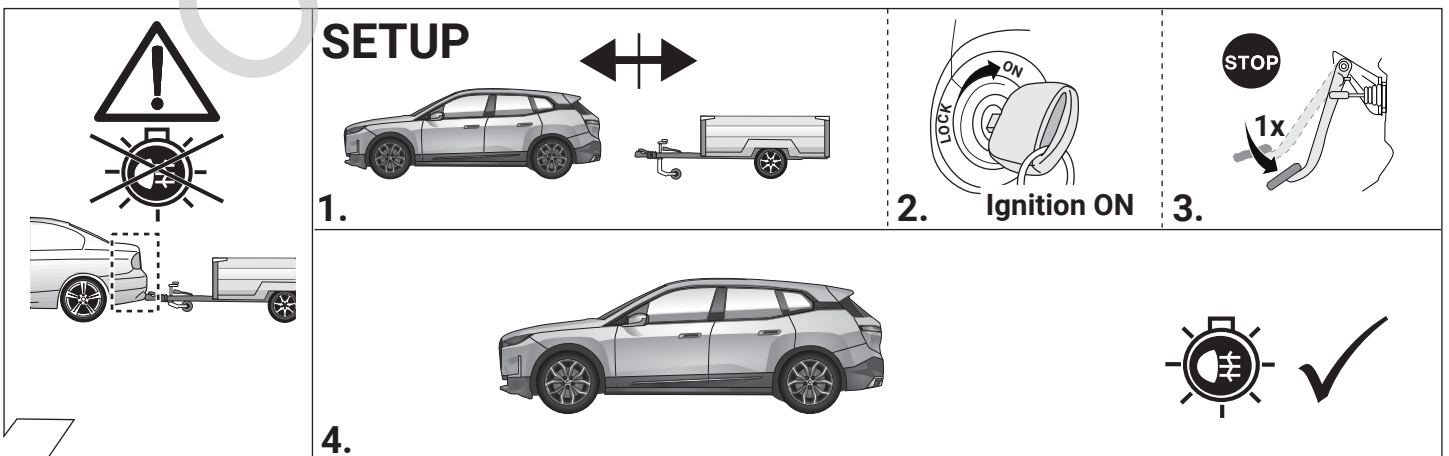

27