



TREKHAKEN • ATTELAGES • ANHÄNGERVORRICHTUNGEN • TOWBARS • ENHANCES • ANHÆNGERTRÆK

Montagehandleiding | instructions de montage | Einbauanleitung | Mounting instruction
Instrucciones de montaje | monteringsvejledning



Opel Cascada

'13-

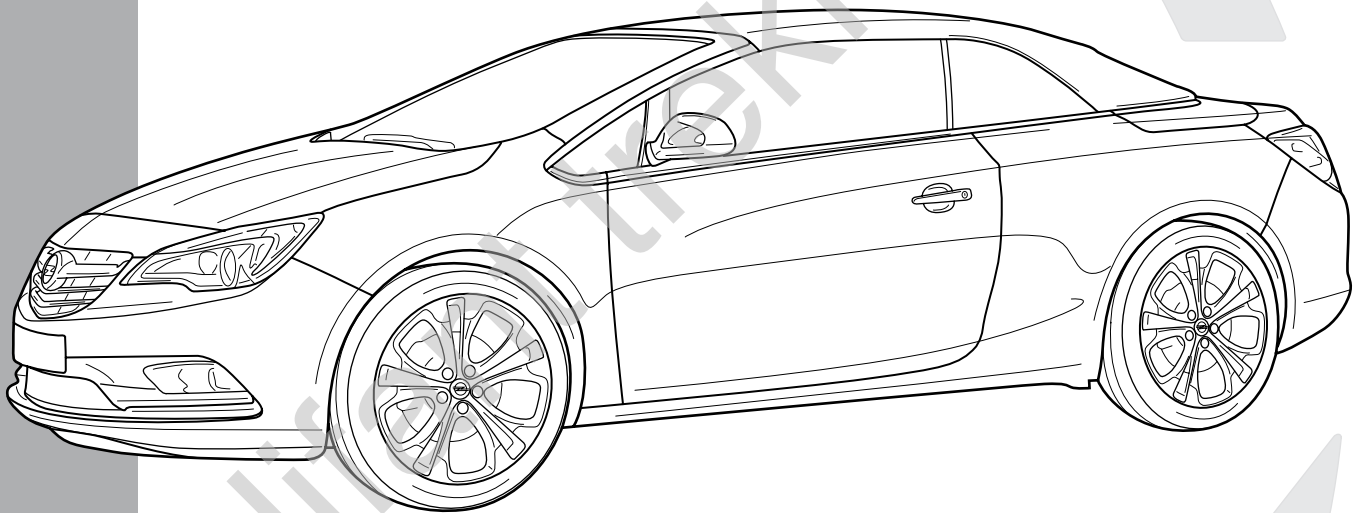

See the Certificate Of Conformity (COC) of your vehicle or contact your dealer to verify the max. trailer weight of your car!



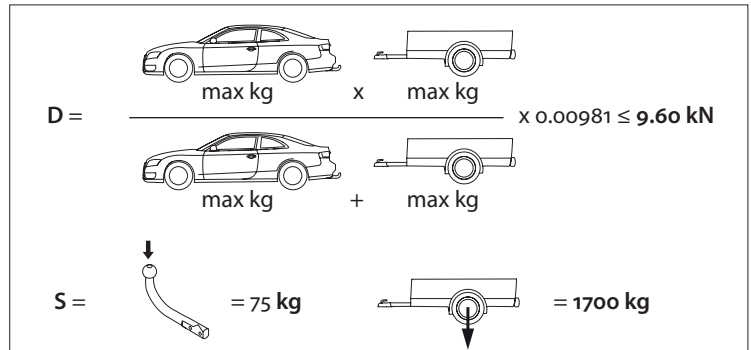



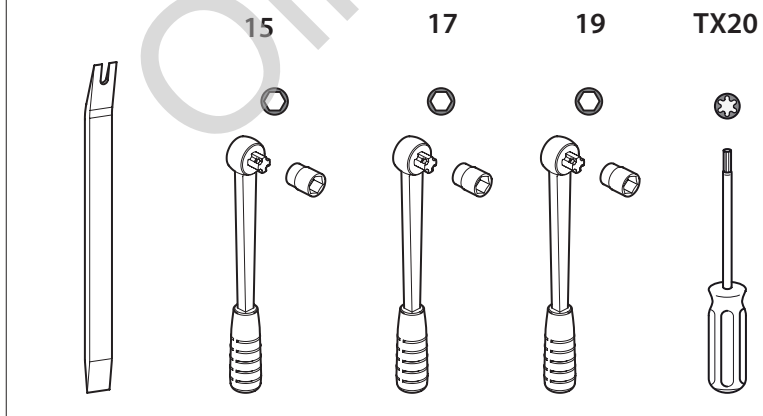
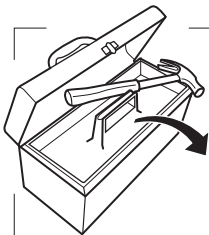

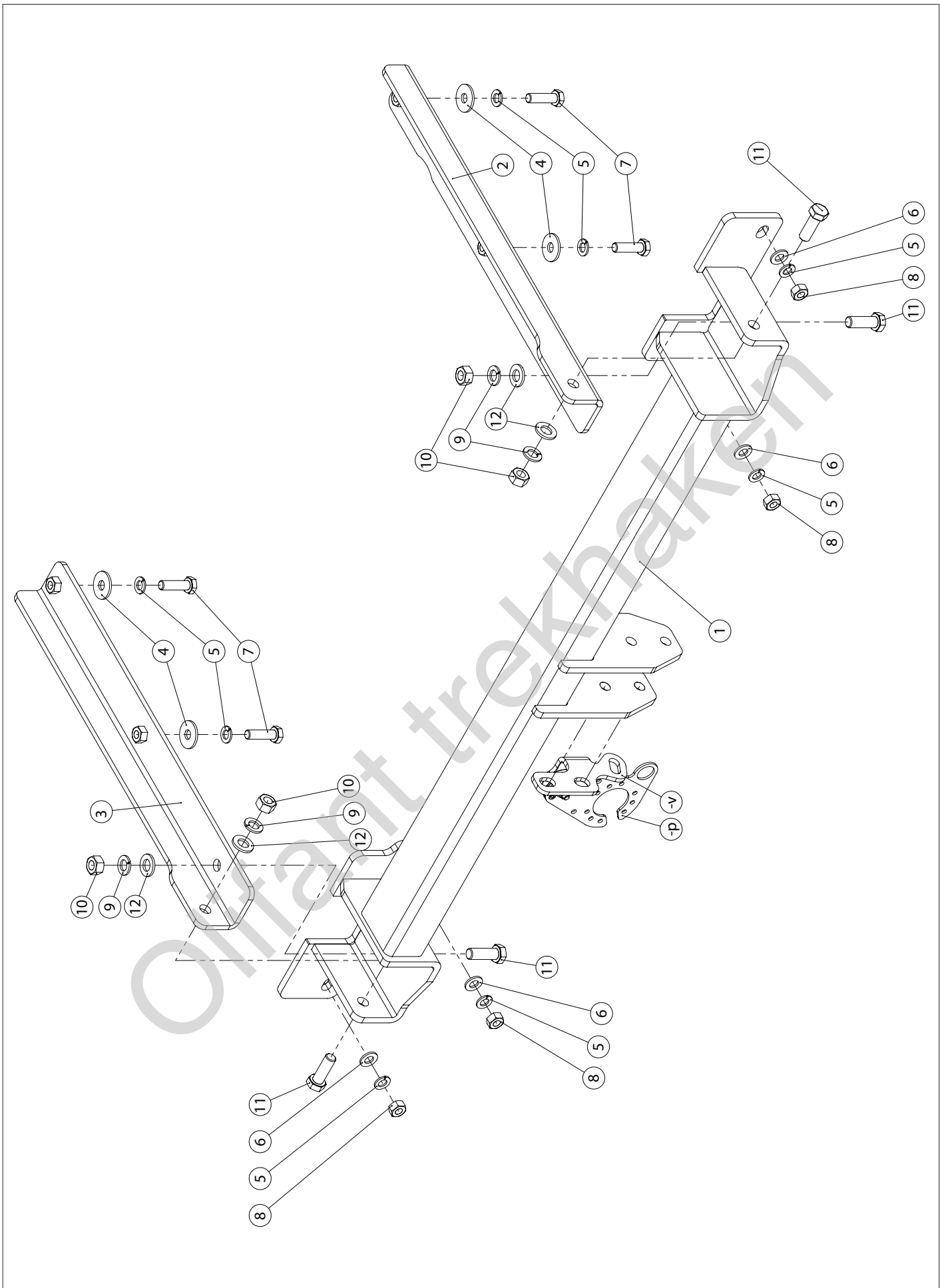

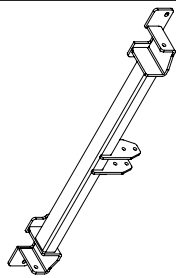
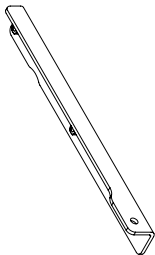
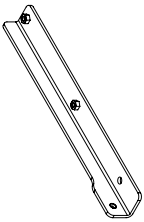
MADE BY	D 9,60	F	E6
			
BELGIUM	S 75	EC APPROVAL N° 55R-011082	
REF N°	SERIE N°		
1993T60			
OMSCHRIJVING			
Opel Cascada '13-			











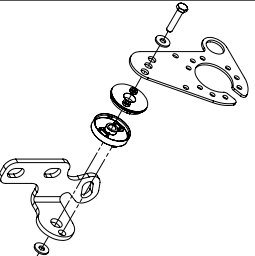
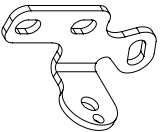



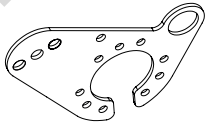

	M 6	M 8	M 10	M 12	M 14	M 16
8.8	10,4 Nm	25,0 Nm	51,0 Nm	87,0 Nm	140,0 Nm	215,0 Nm
10.9	15,5 Nm	37,0 Nm	75,0 Nm	130,0 Nm	205,0 Nm	310, Nm
12.9	18,0 Nm	43,0 Nm	87,0 Nm	150,0 Nm	240,0 Nm	370,0 Nm

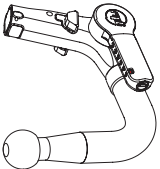
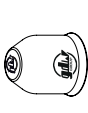
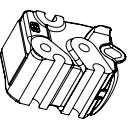

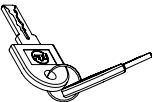

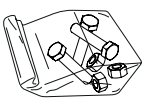
1		X1	GDW REF. 1993T60
2		X1	GDW REF. 2
3		X1	GDW REF. 3
4		X4	DIN9021-M10-ELVZ
5		X8	DIN128A-M10
6		X4	DIN125A-M10-ELVZ
7		X4	DIN933-M10X35
8		X4	DIN934-M10
9		X4	DIN128A-M12
10		X4	DIN934-M12
11		X4	DIN933-M12X35
12		X4	DIN125A-M12-ELVZ

-P		X1	GDW REF. P36 + REF. -V
↳		X1	GDW REF. 908.092
↳		X1	DIN985-M6
↳		X2	6,2 X 15,4 X 1,6 (NYLON)
↳		X1	GDW REF. 718.16.002
↳		X1	GDW REF. 718.16.003
↳		X1	GDW REF. 908.094
↳		X1	DIN933-M6 X 30

Geleverd met - Livré avec - Delivered with Geliefert mit - Elementos adjuntos-Leveres med		X1	GDW REF. 960.V1010
↳		X1	GDW REF. 740.200
↳		X1	GDW REF. 912.003
↳		X1	GDW REF. 740.112
↳		X1	GDW REF. 740.111
↳		X1	GDW REF. 740.114
↳		X1	GDW REF. 718.15.001
↳		X1	GDW REF. SYST60-100
↳		X2	DIN933-M12 X 25
↳		X2	DIN933-M12 X 20
↳		X4	Ø 14 X 24 X 1
↳		X4	DIN128A-M12

1

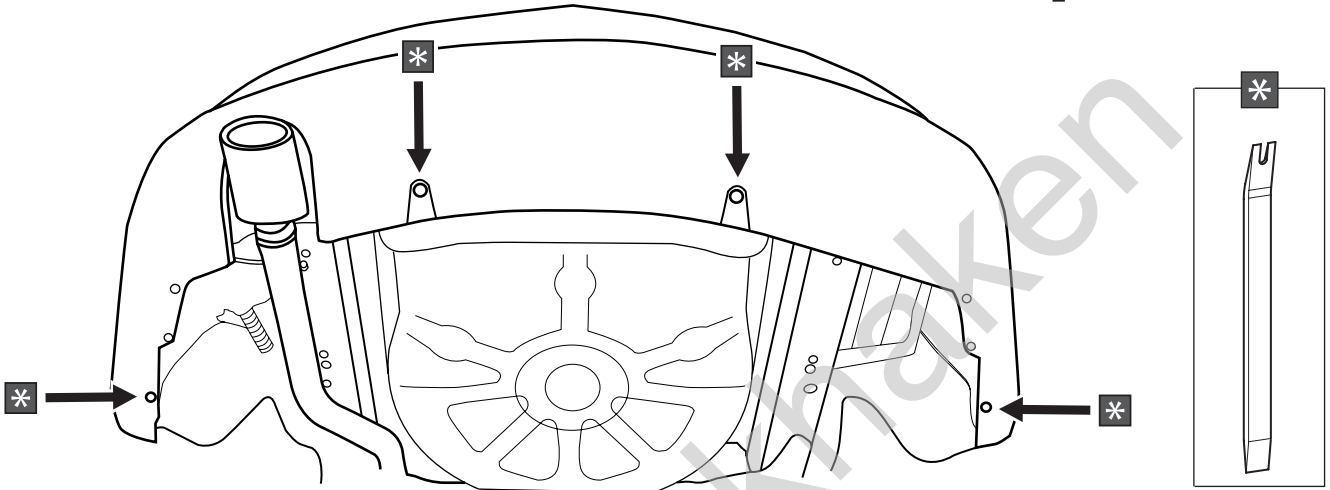
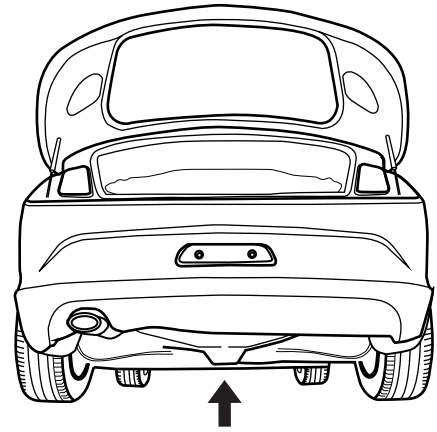

2

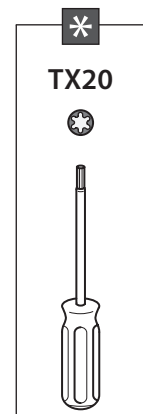
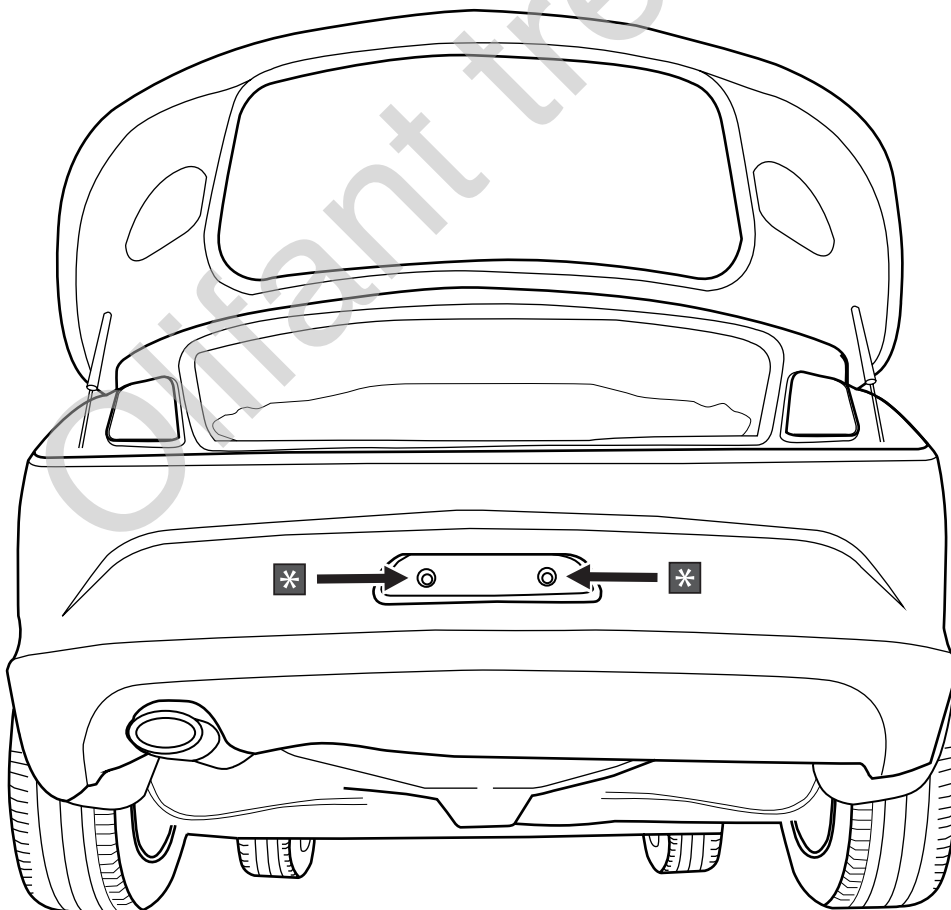

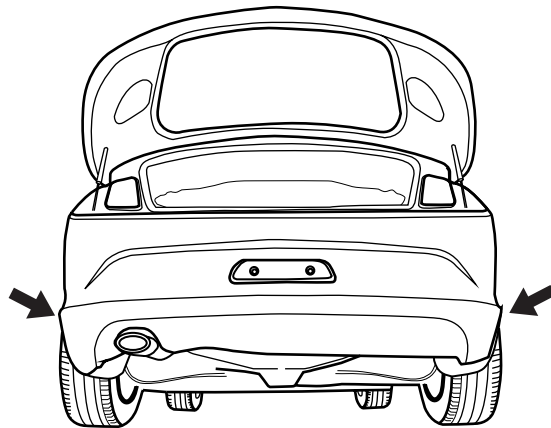

1

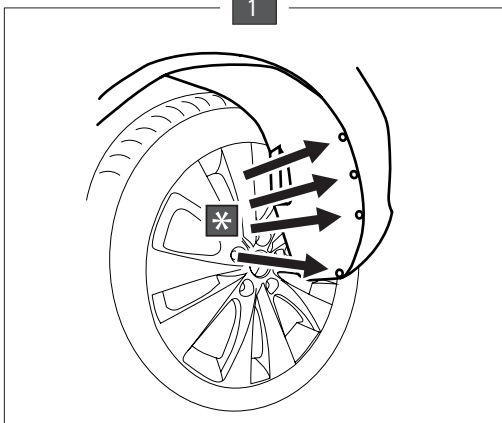

*

TX20

*





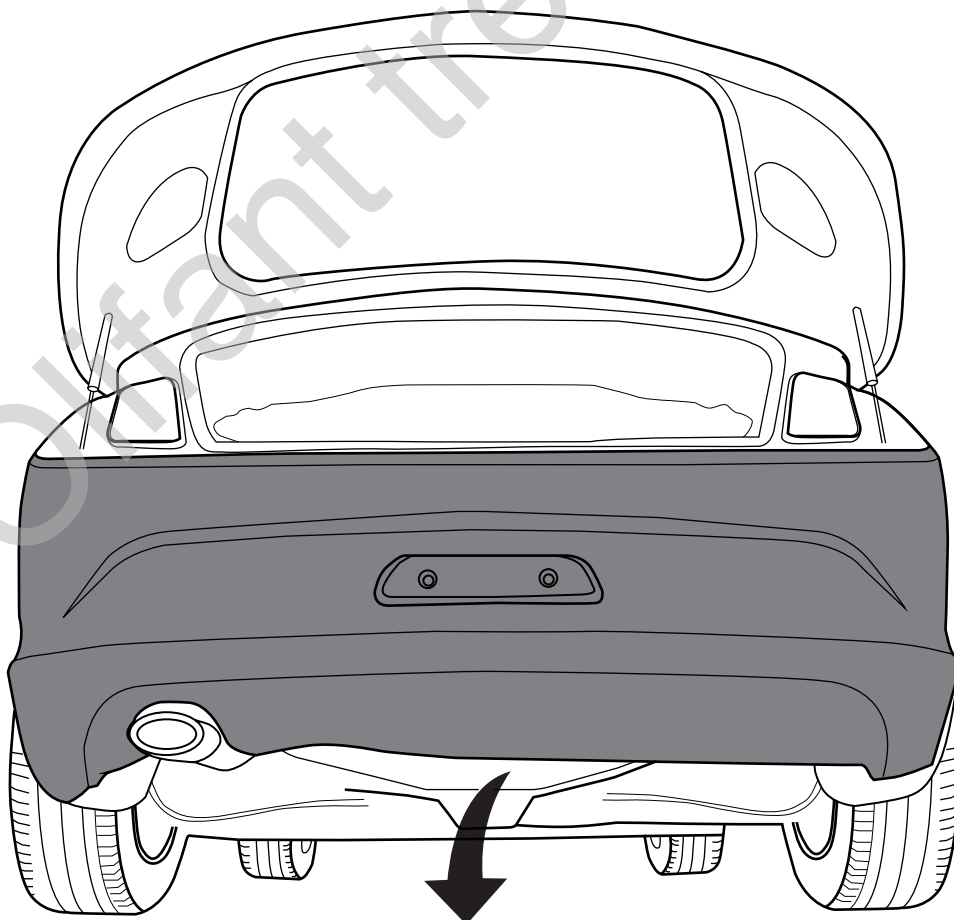
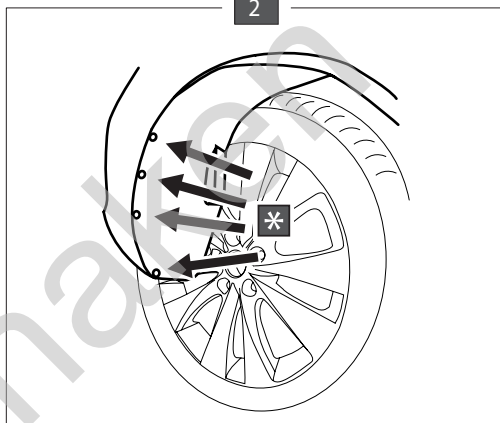

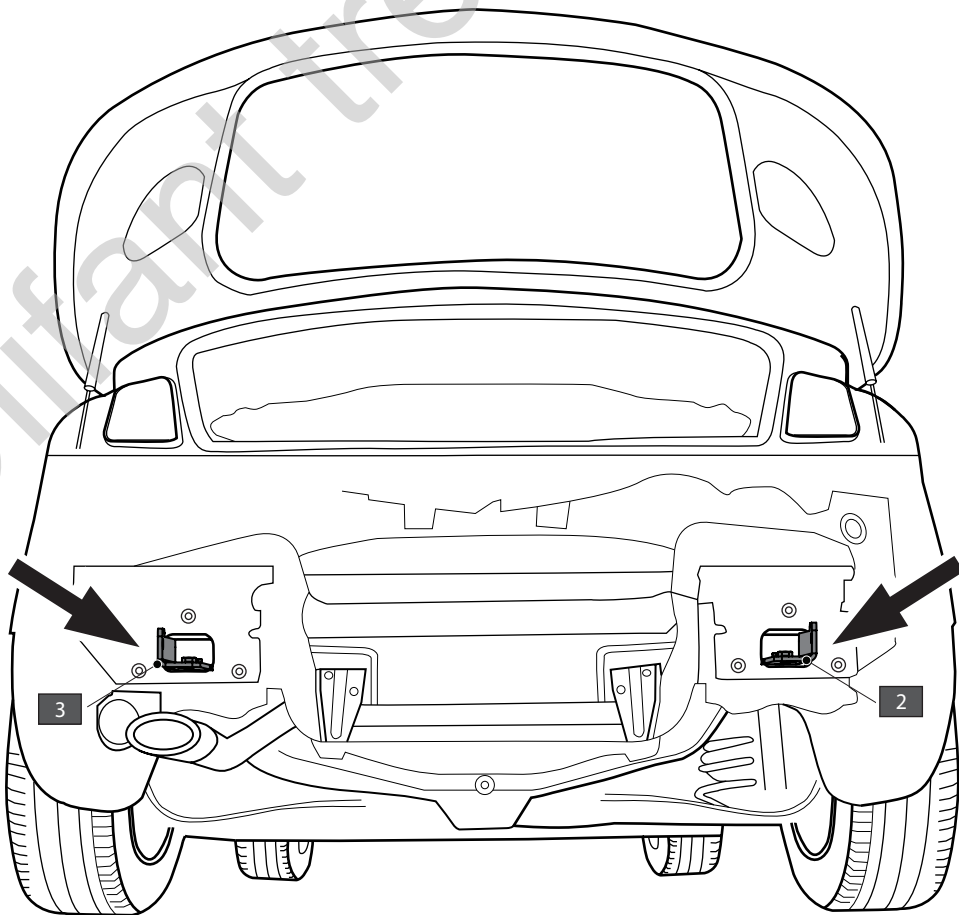
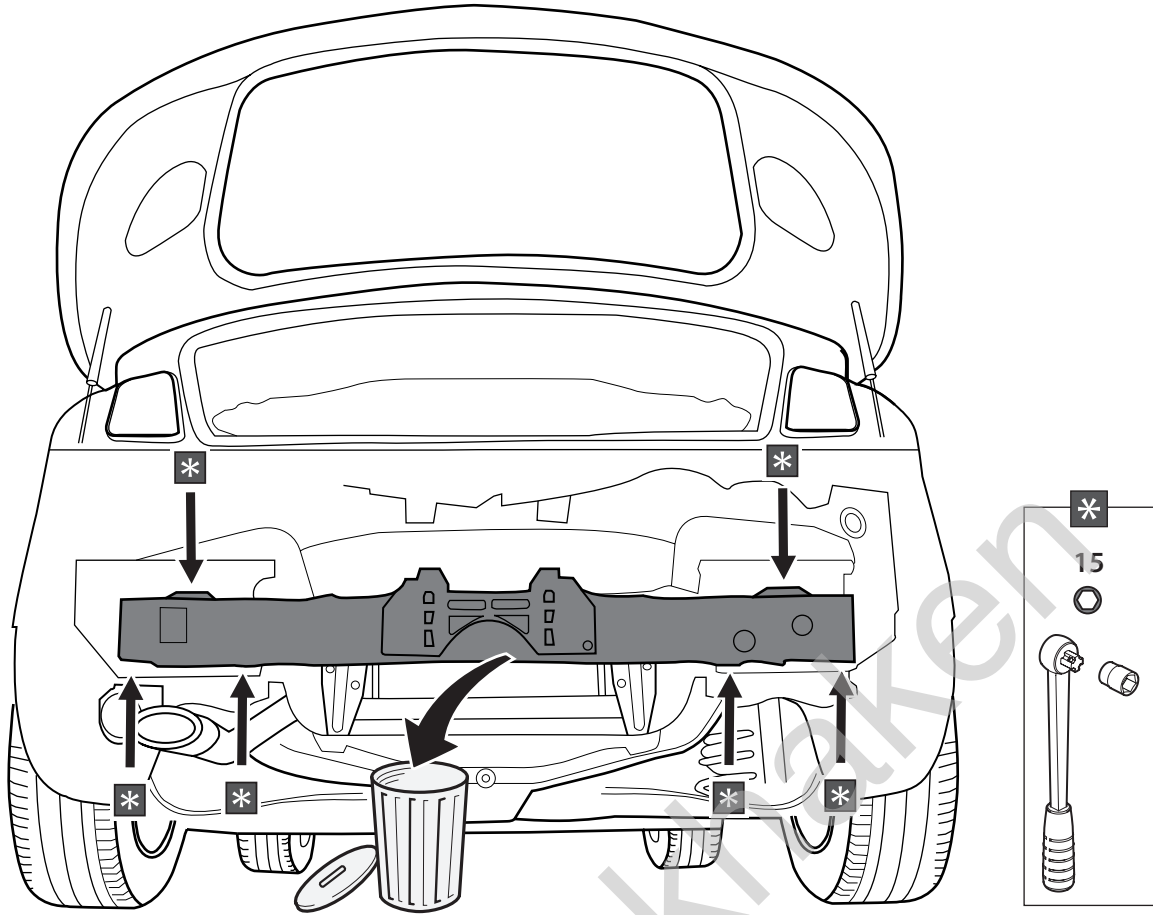

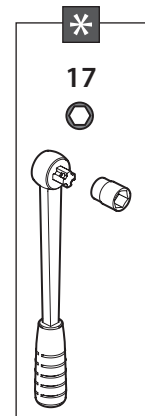
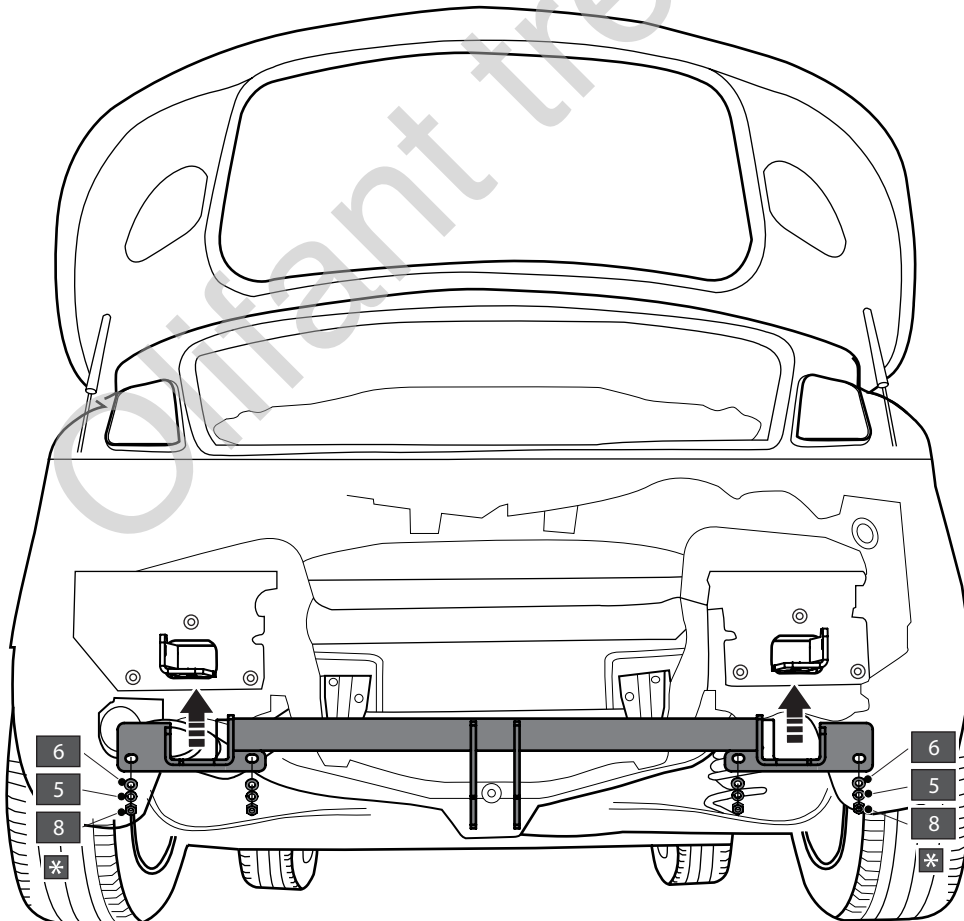
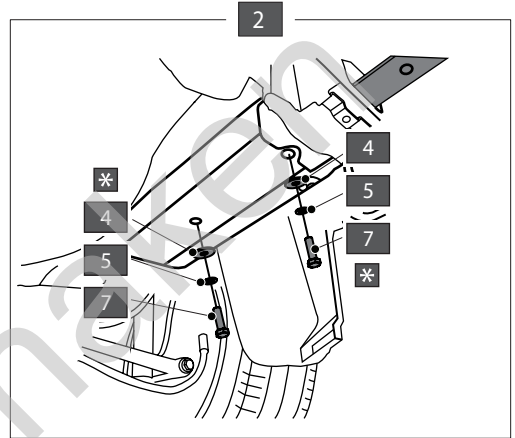
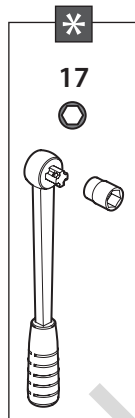
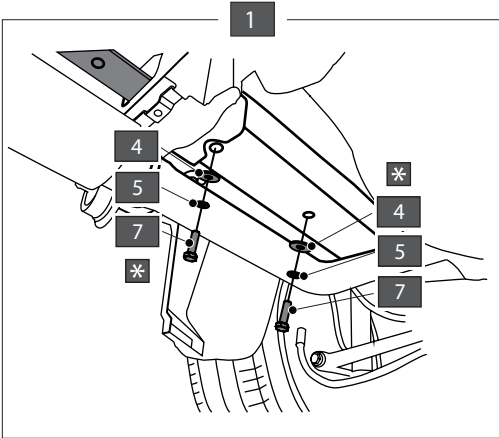
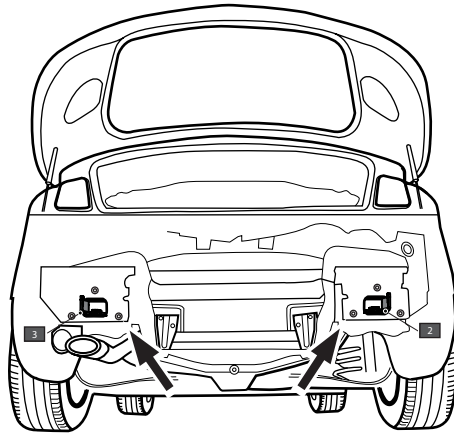
2

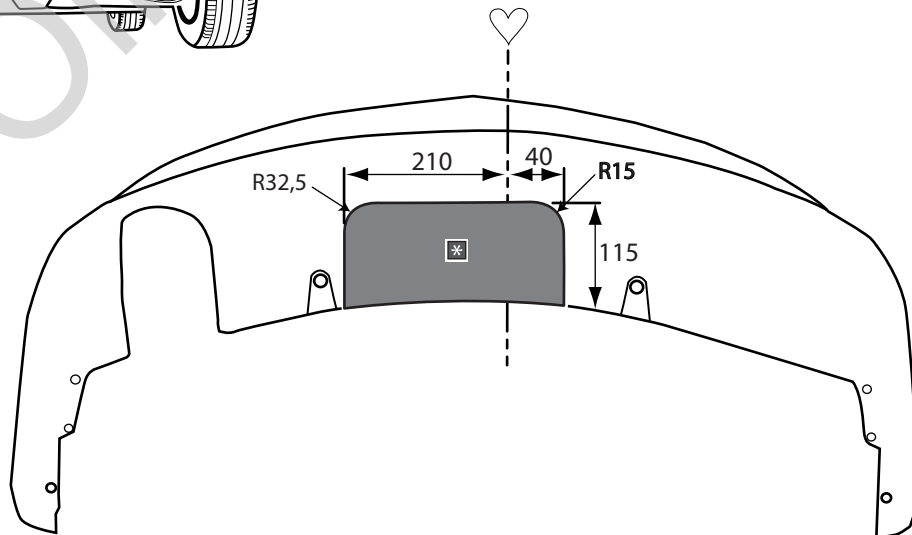
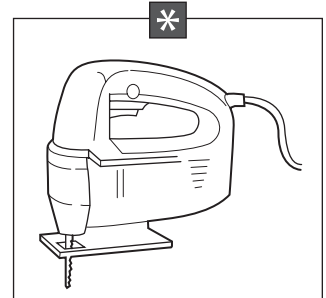
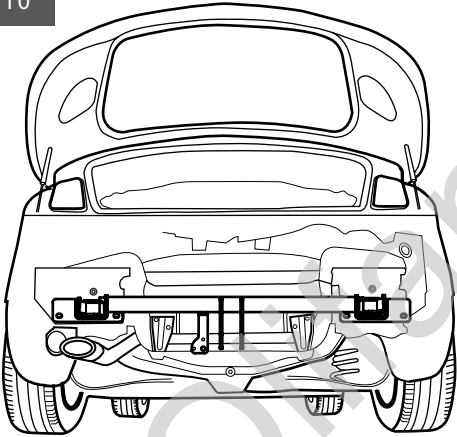
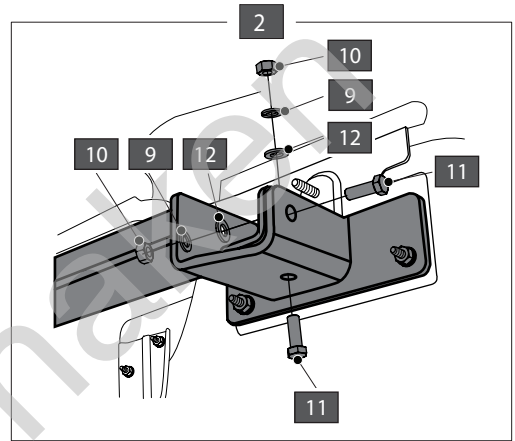
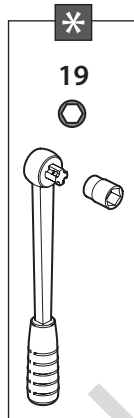
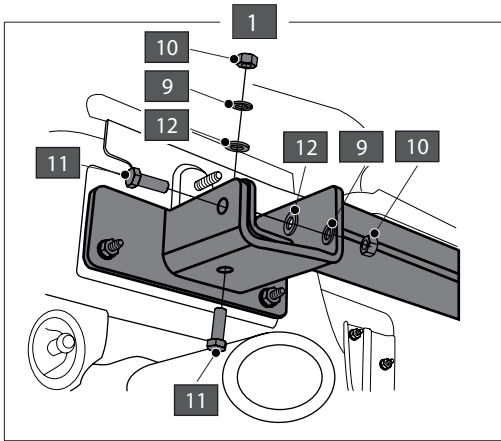
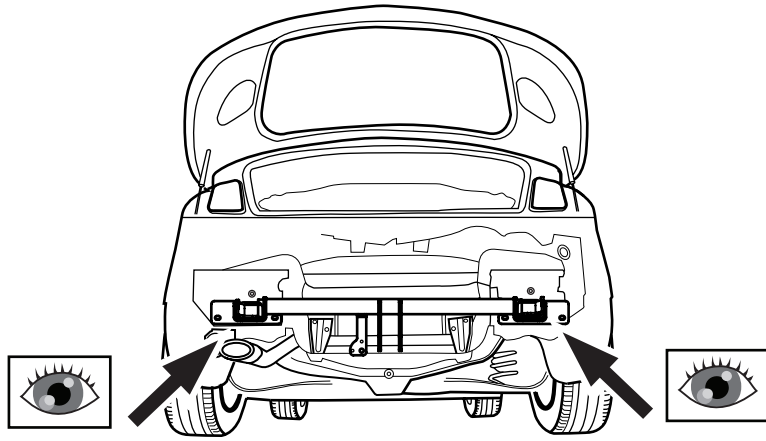

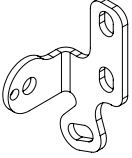





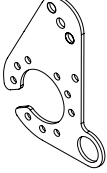

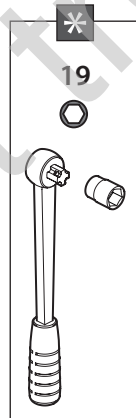
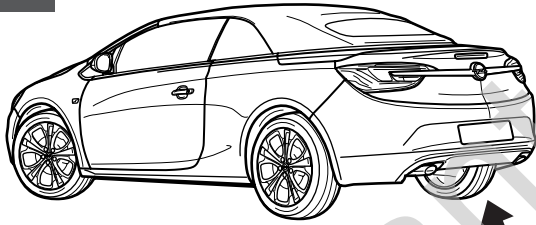
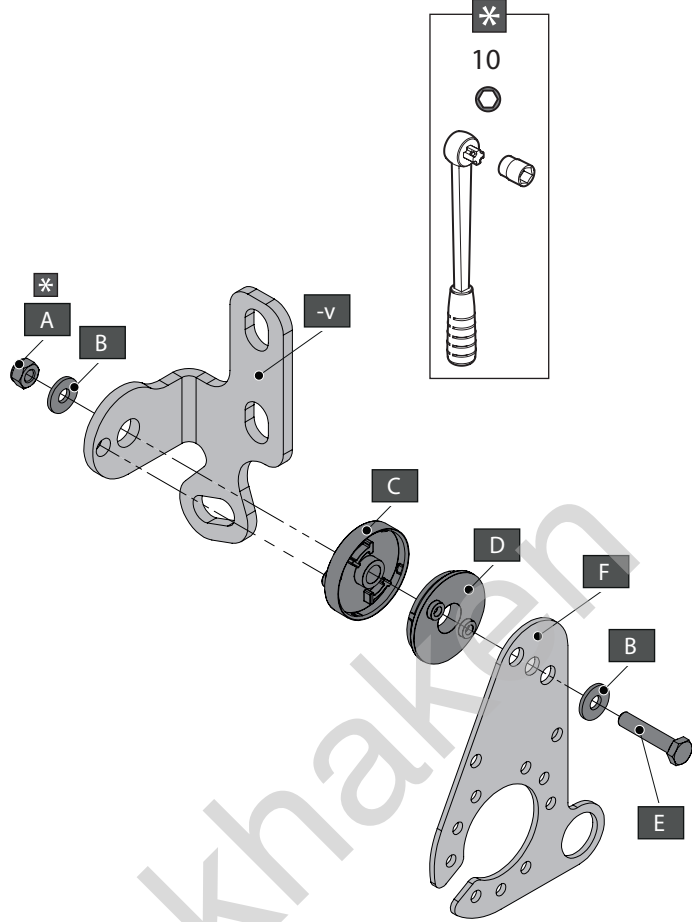

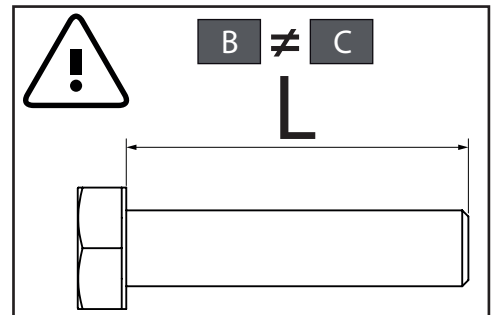

-V		X1	GDW REF. 908.092
A		X1	DIN985-M6
B		X2	6,2 X 15,4 X 1,6 (NYLON)
C		X1	GDW REF. 718.16.002
D		X1	GDW REF. 718.16.003
E		X1	DIN933-M6 X 30
F		X1	GDW REF. 908.094



85,0 Nm



A		X1	912.003
B		X2	DIN933-M12 X 25
C		X2	DIN933-M12 X 20
D		X4	Ø 14 X 24 X 1
E		X4	DIN128A-M12

