

Trekhaken - Attelages - Anhängervorrichtungen - Tow bars



**Mercedes E-klasse (Type W212)**





**2009 - ....**



**GDW Ref. 1769T60**

**EEC APPROVAL N° :**

**e6\*94/20\*0812\*00**

max ↓ kg 	X	max ↓ kg 			
D=			X 0.00981	≤	11,4 KN
max ↓ kg 	+	max ↓ kg 			
S/			=		85 Kg
Max. 			=		2100 Kg

**GDW nv - Hoogmolenwegel 23 - B-8790 Waregem**  
**TEL. 32 (0) 56 60 42 12 (L5) - FAX. 32 (0) 56 60 01 93**  
 E-Mail : [gdw@gdwtowbars.com](mailto:gdw@gdwtowbars.com) - Website : [www.gdwtowbars.com](http://www.gdwtowbars.com)



Mercedes E-klasse (Type W212)

2009 - ....

Ref. 1769T60

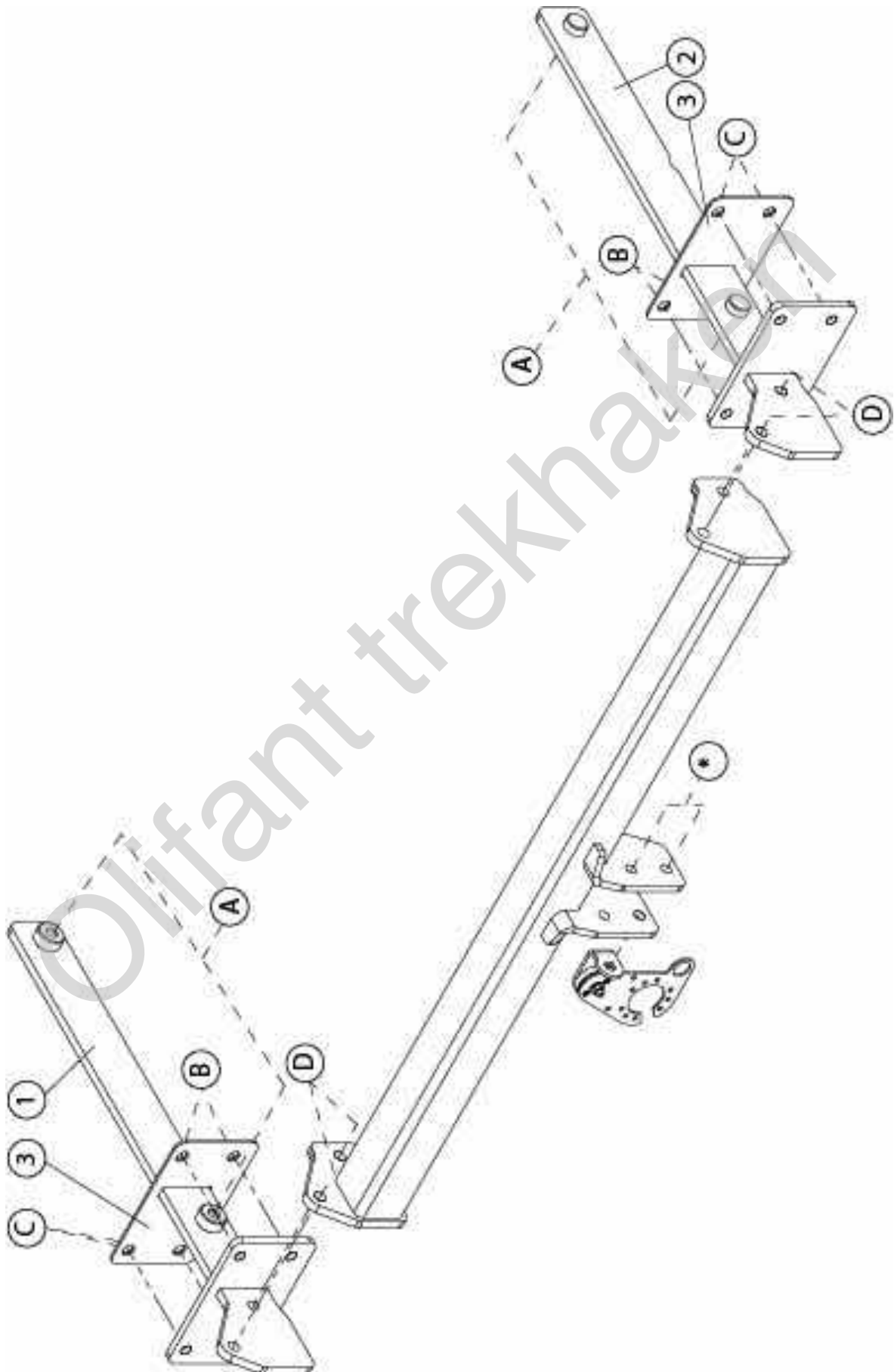



# Mercedes E-klasse (Type W212)

2009 - ....

Ref. 1769T60

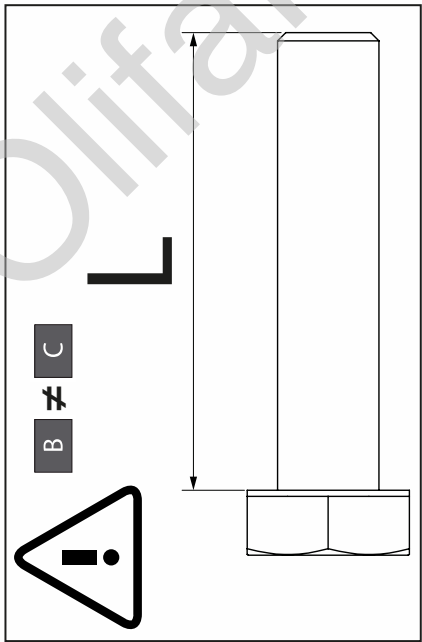
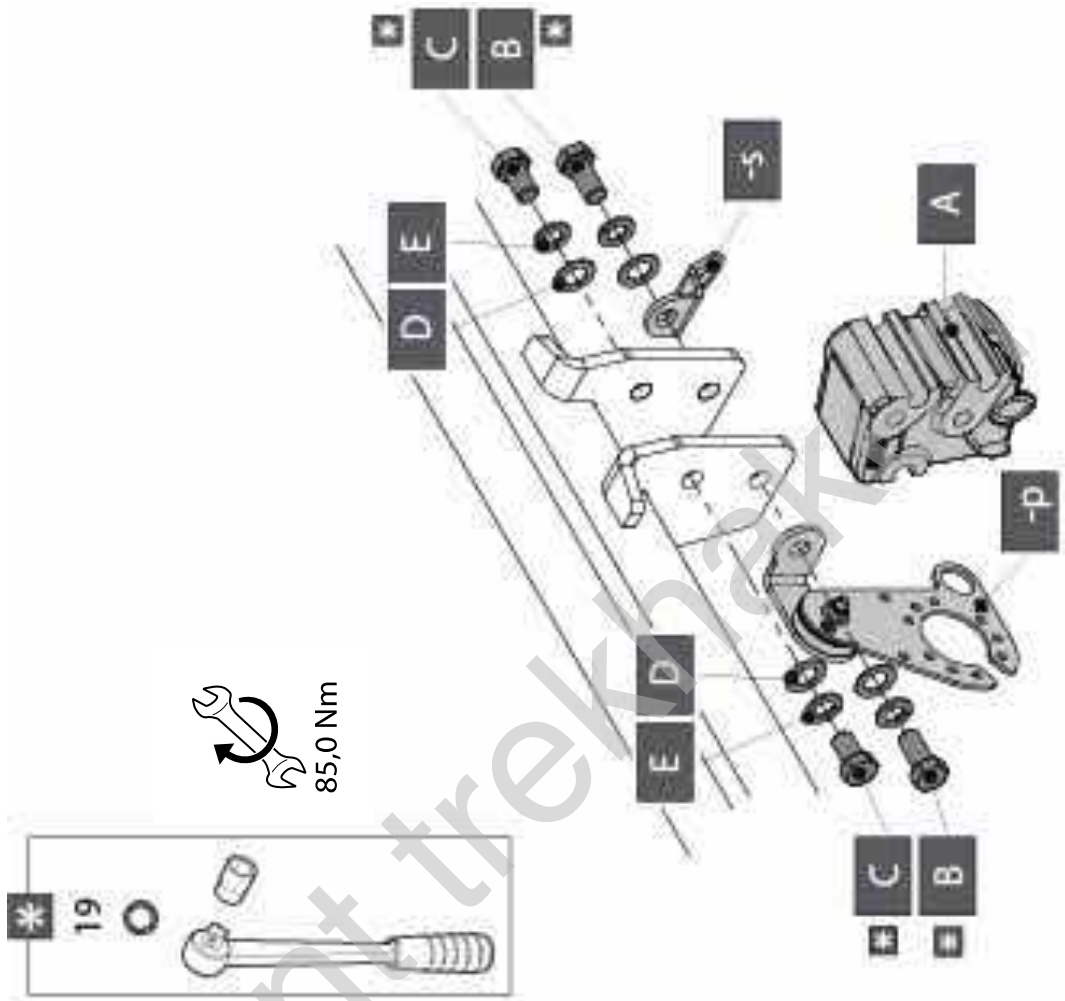

A	X1	GDW REF. 912.003
B	X2	DM933-M12 X 25
C	X3	DM933-M12 X 20
D	X4	Ø 14 X 24 X 1
E	X4	DM12BA-M12

### Hinweise

Die Maximale Anhängelast ihres Fahrzeuges können Sie im Fahrzeugschein oder im Benutzerhandbuch nachlesen.

Im Bereich der Anlageflächen muß Unterbodenschutz und Antiröhmaterial entfernt werden.

Vor dem Bohren prüfen, daß keine, dort eventuell Leitungen beschädigt werden können







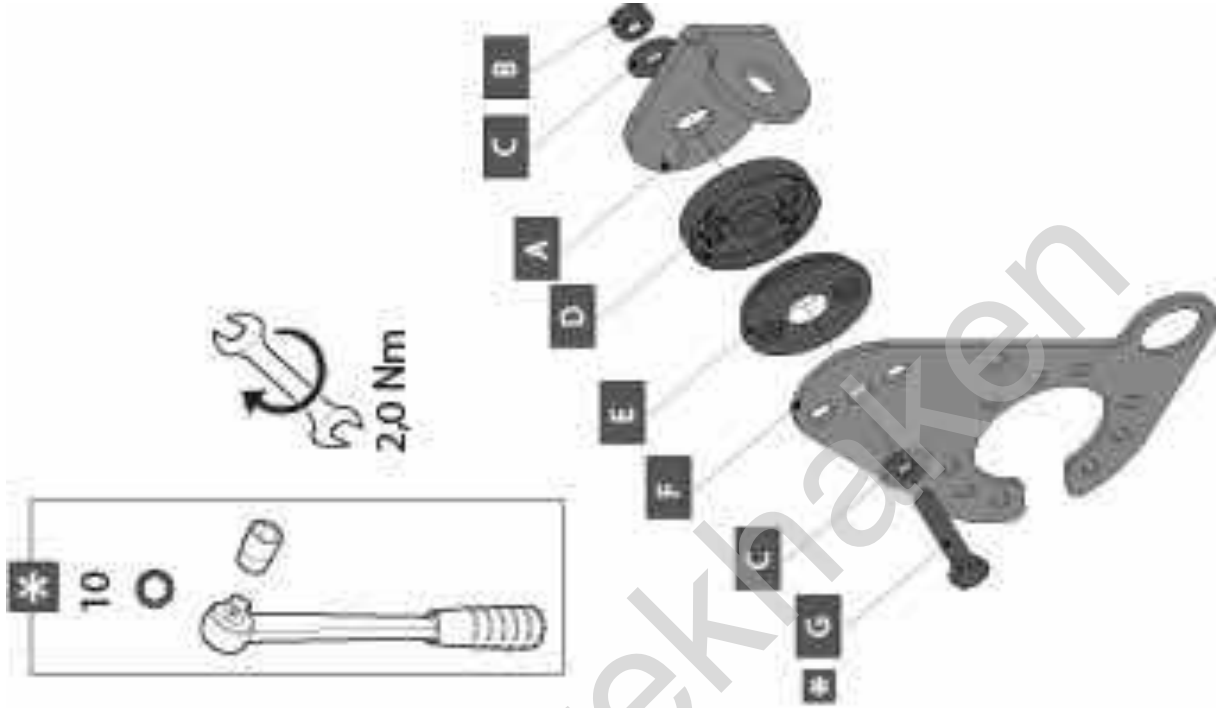

# Mercedes E-klasse (Type W212)

2009 - ....

Ref. 1769T60



	X1	908.098
	X1	DN985-M6
	X2	6.2 X 15.4 X 1.6 (N/LOK)
	X1	GDW REF. 7*8.16.002
	X1	GDW REF. 7*8.16.003
	X1	GDW REF. 908.094
	X1	DN933-M6 X 30