

FITTING INSTRUCTION

Clamp mark in acc. with		Cables joining
ISO	PN	
1	L	Left directional lights
2	+	Rear fog lights
3	31	Ground
4	R	Right directional lights
5	58R	Right side parking lights
6	54	Stoptlights
7	58L	Left side parking lights

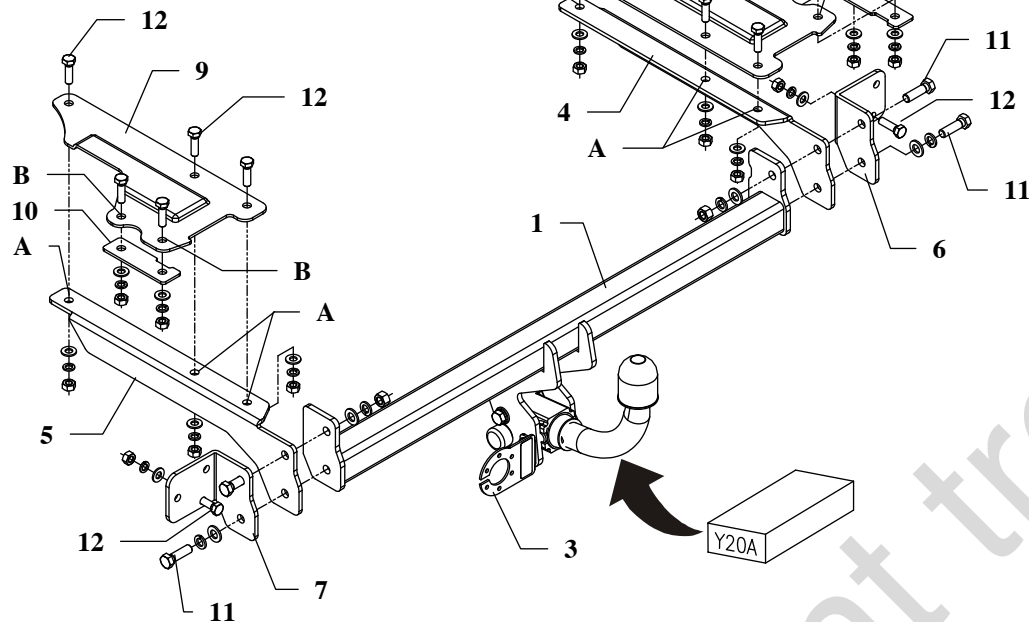

This towing hitch is designed to assembly in following cars:
HONDA CIVIC, 5 doors, except 2.0i Sport, produced since 03.2001 till 12.2005, catalogue no. **Y20A** and is prepared to tow trailers max total weight **1200 kg** and max vertical load **50 kg**.

From manufacturer

Thank you for buying our product. Their reliability has been confirmed in many tests. Reliability of towing hitch depends also on correct assembly and right operation. For this reasons we kindly ask to read carefully this instruction and apply to hints.

The towing hitch should be install in points described by a car producer.

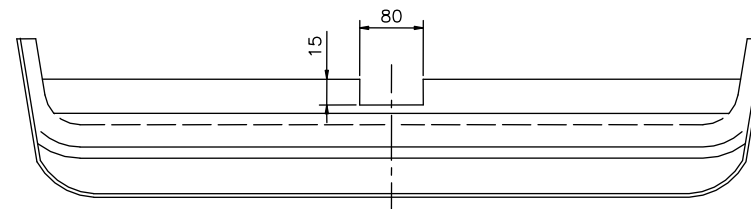

Fig. 2 Bumper cut out

The instruction of the assembly

1. Disassemble a bumper, muffler and metal reinforcement (not used any more) and take out side and rear covers inside the trunk.
2. In bottom part of the bumper cut out fragment according to figure 2.
3. On protruding pins in rear wall of car body put left handle (pos. 7) on the left side and right handle (pos. 6) on the right side and fix using original nuts M8 from metal reinforcement disassembly and per one bolt M10x35mm (pos. 12) from accessories (fix loosely).
4. With in this way prepared elements fix side brackets (pos. 4 and 5) and main bar of the towing hitch pos. 1 using bolts M12x40mm (pos. 11) – see drawing.
5. Through holes pos. A of side brackets drill holes $\varnothing 11$ mm, straight through.
6. Inside the trunk put fish-plates (pos. 8 and 9) in this way, so holes of the fish-plates agree with holes drilled before and fix loosely using bolts M10x35mm (pos. 12).
7. Through holes pos. B of fish-plates drill straight through holes $\varnothing 11$ mm and next fix with rectangular washer (pos. 10) by bolts M10x35mm (pos. 12).
8. Reassemble the bumper and the muffler.
9. Fix body of the automat and place tow-ball according to supplied instruction. Note! Remember to place socket plate (pos. 3) as shown on the drawing 1.
10. Connect electric wires of 7-poles socket according to the instruction of the car. (Recommend to make at authorized service station)
11. Complete paint layer damaged during installation.

Torque settings for nuts and bolts (8,8):	
M 8 - 25 Nm	M 10 - 55 Nm
M 12 - 85 Nm	M 14 - 135 Nm







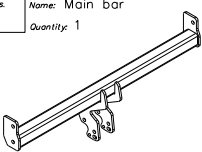

NOTE

After install the towing hitch you should get adequate note in registration book (at authorised service station).The car should be equipped with:

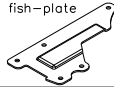
- Indicators
- Tow mirrors

After 1000km check all bolts. The ball of towing hitch must be always kept clear and conserve with a grease.

Towing hitch accessories:

Pos. 1 Name: Main bar Quantity: 1	Pos. 5 Name: Left bracket Quantity: 1	Pos. 10 Name: Rectangular washer Quantity: 2	Pos. 15 Name: Plain washer Quantity: 4 Dim.: Ø 13 mm
	Pos. 6 Name: Right handle Quantity: 1	Pos. 11 Name: Bolt 8,8 B Quantity: 4 Dim.: M12x40mm	Pos. 16 Name: Plain washer Quantity: 12 Dim.: Ø 10,5 mm
Pos. 2 Name: Tow ball Quantity: 1	Pos. 7 Name: Left handle Quantity: 1	Pos. 12 Name: Bolt 8,8 B Quantity: 12 Dim.: M10x35mm	Pos. 17 Name: Spring washer Quantity: 4 Dim.: Ø 12,2 mm
	Pos. 8 Name: Right fish-plate Quantity: 1	Pos. 13 Name: Nut 8 B Quantity: 2 Dim.: M12	Pos. 18 Name: Spring washer Quantity: 12 Dim.: Ø 10,2 mm
Pos. 3 Name: Socket plate Quantity: 1		Pos. 14 Name: Nut 8 B Quantity: 12 Dim.: M10	
Pos. 4 Name: Right bracket Quantity: 1	Pos. 9 Name: Left fish-plate Quantity: 1		
			



PPUH AUTO-HAK S.J.

Produkcja Haków Holowniczych
Henryk i Zbigniew Nejman
76-200 SŁUPSK ul. Słoneczna 16K
tel./fax (059) 8-414-414; 8-414-413
e-mail: office@autohak.com.pl
www.autohak.com.pl

Towing hitch (without electrical set)

Class: **A50-X** Cat. no. **Y20A**

Designed for:

Manufacturer: **HONDA**

Model: **CIVIC**

Type: **5 doors, except 2.0i Sport**

produced since 03.2001 till 12.2005

Technical data:

D-value: 6,83 kN

maximum trailer weight: **1200 kg**

maximum vertical cup load: **50 kg**

Approval number according to Directive 94/20/EC: **e20*94/20*0498*00**

Foreword

This towing hitch is designed according to rules of safety traffic regulations. The towing hitch is a safety component and can be install only by qualified personnel. Any alteration or conversion of the towing hitch is prohibited and would lead to cancellation of design certification. Remove insulating compound and underseal from vehicle (if present) in the area of the matting surfaces of the towing hitch. The vehicle manufacturer's specifications regarding trailer load and max. vertical cup load are decisive for driving, and values for the towing hitch cannot be exceeded.

D-value formula:

$$\frac{\text{Max trailer weight [kg]} \times \text{Max vehicle weight [kg]}}{\text{Max trailer weight [kg]} + \text{Max vehicle weight [kg]}} \times \frac{9,81}{1000} = D \text{ [kN]}$$