

FITTING INSTRUCTION

Clamp mark in acc. with		Cables joining
ISO	PN	
1	L	Left directional lights
2	+	Rear fog lights
3	31	Ground
4	R	Right directional lights
5	58R	Right side parking lights
6	54	Stoptlights
7	58L	Left side parking lights

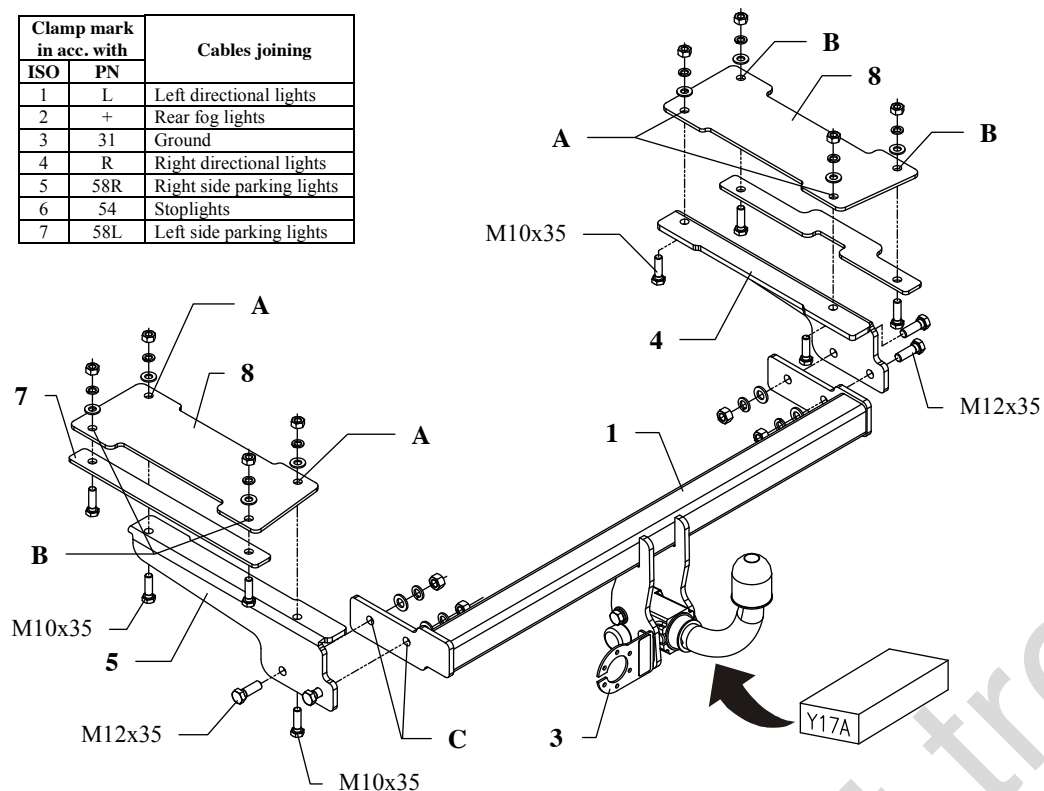

Fig. 1

This towbar is designed to assembly in following cars:
HONDA CIVIC, 4 door, produced since 03.1999 till 10.2000, catalogue no. **Y17A** and is prepared to tow trailers max total weight **1300 kg** and max vertical load **50 kg**.

From manufacturer

Thank you for buying our product. Their reliability has been confirmed in many tests. Reliability of towbar depends also on correct assembly and right operation. For this reasons we kindly ask to read carefully this instruction and apply to hints.

The towbar should be install in points described by a car producer.

The instruction of the assembly

1. For the purpose of installing of the towbar one ought to disassemble the bumper.
2. From the bottom of the car mark points according to fig. 2. Next drill holes using bit $\varnothing 11\text{mm}$, make it very carefully.
3. Inside the trunk put suitable upper fish-plates (pos. 8) on to made holes.
4. From the bottom of the car put side brackets (pos. 4 and 5) and through holes (pos. A) and fish-plates (pos. 8) fix using bolts M10x35mm (pos. 10).
5. From the bottom of the car put fish-plates (pos. 6 and 7), next through holes (pos. B) and fish-plates (pos. 8) fix using bolts M10x35mm (pos. 10).
6. Through holes (pos. C) fix main bar of the towbar (pos. 1) with side brackets using bolts M12x35mm (pos. 9).
7. Tighten all bolts according to the torque shown in the table.
8. Install the bumper after cut out of its fragments (see fig. 3).
9. Fix body of the automat and place tow-ball according to supplied instruction. Note! Remember to place socket plate (pos. 3) as shown on the drawing 1.
10. Connect electric wires of 7-poles socket according to the instruction of the car. (Recommend to make at authorized service station).
11. Complete paint layer damaged during installation.

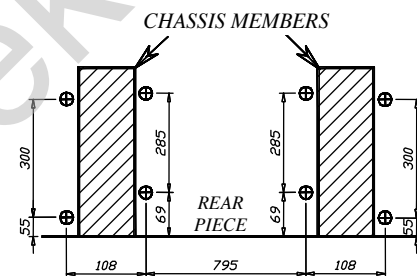

Fig. 2 View from the bottom of the car (after take off the bumper)

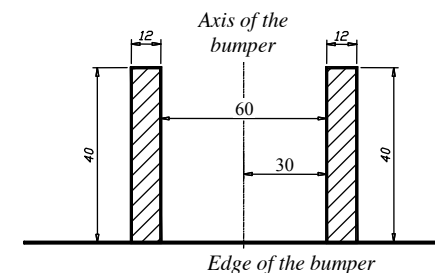

Fig. 3

Torque settings for nuts and bolts (8,8):

M 8 - 25 Nm **M 10 - 55 Nm**
M 12 - 85 Nm **M 14 - 135 Nm**









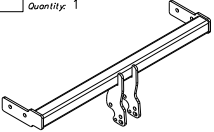
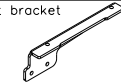

NOTE

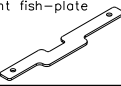
After install the towbar you should get adequate note in registration book (at authorised service station).The car should be equipped with:

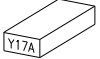
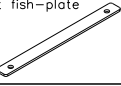
- Indicators
- Tow mirrors

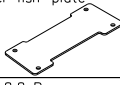
After 1000km of exploitation check all bolts and nuts. The ball of towbar must be always kept clear and conserve with a grease.

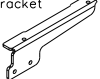
Towbar accessories:

Pos. 1 Name: Main bar Quantity: 1 	Pos. 5 Name: Left bracket Quantity: 1 	Pos. 10 Name: Bolt 8,8 B Quantity: 8 Dim.: M10x35mm 	Pos. 15 Name: Spring washer Quantity: 4 Dim.: Ø 12,2 mm 
	Pos. 6 Name: Right fish-plate Quantity: 1 	Pos. 11 Name: Nut 8 B Quantity: 4 Dim.: M12 	Pos. 16 Name: Spring washer Quantity: 8 Dim.: Ø 10,2 mm 
Pos. 2 Name: Tow ball Quantity: 1 	Pos. 7 Name: Left fish-plate Quantity: 1 	Pos. 12 Name: Nut 8 B Quantity: 8 Dim.: M10 	
Pos. 3 Name: Socket plate Quantity: 1 	Pos. 8 Name: Upper fish-plate Quantity: 2 	Pos. 13 Name: Plain washer Quantity: 4 Dim.: Ø 13 mm 	
Pos. 4 Name: Right bracket Quantity: 1 	Pos. 9 Name: Bolt 8,8 B Quantity: 4 Dim.: M12x35mm 	Pos. 14 Name: Plain washer Quantity: 8 Dim.: Ø 10,5 mm 	



PPUH AUTO-HAK S.J.

Produkcja Zaczepów Kulowych
Henryk i Zbigniew Nejman
76-200 SŁUPSK ul. Słoneczna 16K
tel/fax (059) 8-414-414; 8-414-413
email: office@autohak.com.pl
www.autohak.com.pl

Towing hitch (without electrical set)

Class: **A50-X** Cat. no. **Y17A**

Designed for:

Manufacturer: **HONDA**

Model: **CIVIC**

Type: **4 door**

produced since 03.1999 till 10.2000

Technical data:

D-value: 6,07 kN

maximum trailer weight: **1300 kg**

maximum vertical cup load: **50 kg**

Approval number according to Directive 94/20/EC: **e20*94/20*0577*00**

Foreword

This towbar is designed according to rules of safety traffic regulations. The towing hitch is a safety component and can be install only by qualified personnel. Any alteration or conversion of the towing hitch is prohibited and would lead to cancellation of design certification. Remove insulating compound and underseal from vehicle (if present) in the area of the matting surfaces of the towing hitch.

The vehicle manufacturer's specifications regarding trailer load and max. vertical cup load are decisive for driving, and values for the towing hitch cannot be exceeded.

D-value formula:

$$\frac{\text{Max trailer weight [kg]} \times \text{Max vehicle weight [kg]}}{\text{Max trailer weight [kg]} + \text{Max vehicle weight [kg]}} \times \frac{9,81}{1000} = D \text{ [kN]}$$