

## FITTING INSTRUCTION

Clamp mark in acc. with		Cables joining
ISO	PN	
1	L	Left directional lights
2	+	Rear fog lights
3	31	Ground
4	R	Right directional lights
5	58R	Right side parking lights
6	54	Stoplights
7	58L	Left side parking lights

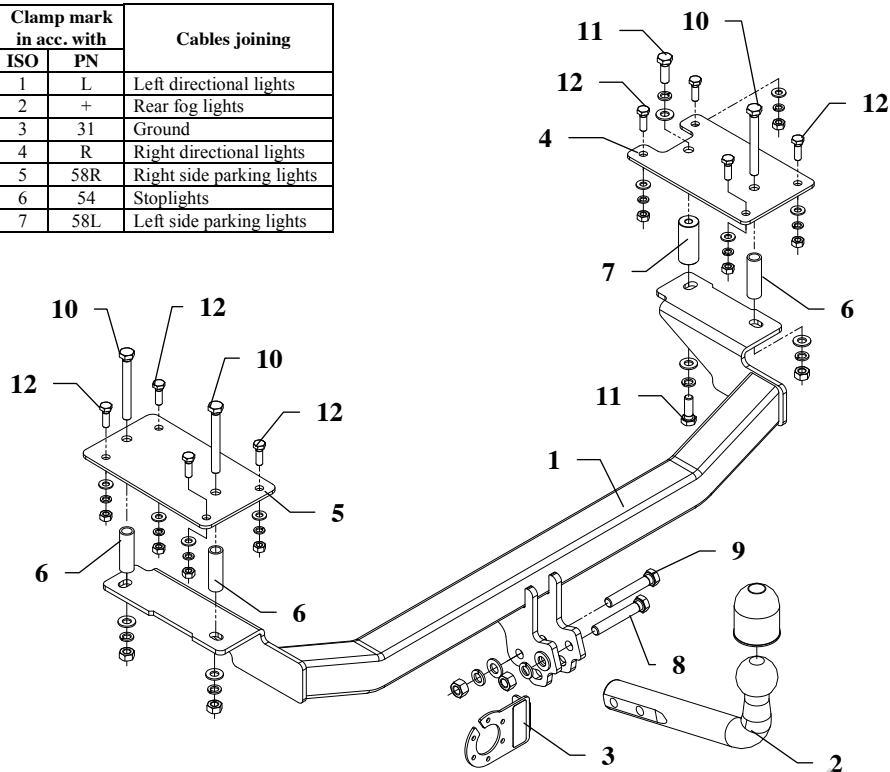

This towbar is designed to assembly in following cars:  
**FIAT SEICENTO SPORTING, 3 doors**, produced since 1998 till 2003, catalogue no. **S008** and is prepared to tow trailers max total weight **400 kg** and max vertical load **28 kg**.

### From manufacturer

Thank you for buying our product. Their reliability has been confirmed in many tests. Reliability of towbar depends also on correct assembly and right operation. For this reasons we kindly ask to read carefully this instruction and apply to hints.

*The towbar should be install in points described by a car producer.*

## The instruction of the assembly



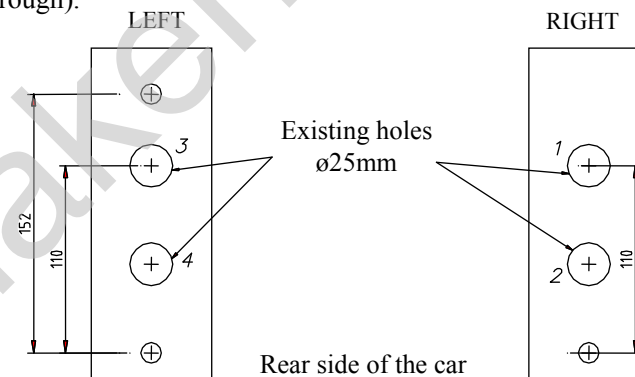







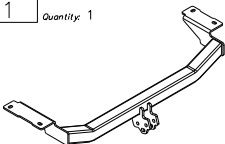





1. Before beginning installation one ought to read instruction of the car (see page 158), in this point manufacturer describe places where towbar should be installed.
2. According to fig. 2 drill holes:
  - Left side – from hole no. 3 measure 110mm to rear side of the car and drill hole  $\varnothing 1$ mm (straight through), from this hole measure 152mm and drill another hole  $\varnothing 1$ mm (straight through too).
  - Right side – from hole no. 1 measure 110mm to rear side of car and drill  $\varnothing 1$ mm (straight through).

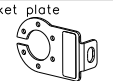
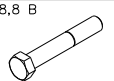

3. Maked holes drill again using bit  $\varnothing 17,5$ mm – only in upper side.
4. To this holes slip distance sleeves  $\varnothing 17$ mm L=55 (pos. 6).
5. To existing hole  $\varnothing 25$  (no. 1, see fig. 2) slip threaded distance sleeve - pos. 7 (from below) and next through its holes drill holes  $\varnothing 1$ mm to inside boot.
6. Put fish-plates (pos. 4 and 5) as shown in drawing and fix using bolts M10x90mm (pos. 10) and bolt M10x30mm (pos. 11).
7. From below the car, put the main bar of towbar (pos. 1) and fix as shown in the figure 1.
8. Through holes in fish-plates (pos. 4 and 5) drill holes  $\varnothing 9$ mm and fix using bolts M8x25mm (pos. 12) as shown in figure 1.
9. Fix tow-ball (pos. 2) and socket plate (pos. 3) using bolts from the towbar accessories, see fig. 1.
10. Tighten all bolts according to the torque shown in the table.
11. Connect electric wires of 7-bolts socket according to the instruction of the car. (Recommend to make at authorized service station)
12. Complete the paint coating damaged during installation.

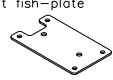
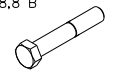
Torque settings for nuts and bolts (8,8):	
<b>M 8</b> - 25 Nm	<b>M 10</b> - 55 Nm
<b>M 12</b> - 85 Nm	<b>M 14</b> - 135 Nm

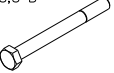
## Towbar accessories:

Pos. 1 Name: Main bar Quantity: 1 	Pos. 5 Name: Left fish-plate Quantity: 1 	Pos. 11 Name: Bolt 8,8 B Quantity: 2 Dim.: M10x30mm 	Pos. 17 Name: Plain washer Quantity: 5 Dim.: Ø 10,5 mm 
	Pos. 6 Name: Distance sleeve Quantity: 3 Dim.: Ø17,2x2,35mm L=55mm 	Pos. 12 Name: Bolt 8,8 B Quantity: 8 Dim.: M8x25mm 	Pos. 18 Name: Plain washer Quantity: 8 Dim.: Ø 8,5 mm 
Pos. 2 Name: Tow ball Quantity: 1 	Pos. 7 Name: Distance sleeve Quantity: 1 Dim.: Ø24mm L=55xM10 	Pos. 13 Name: Nut 8 B Quantity: 2 Dim.: M12 	Pos. 19 Name: Spring washer Quantity: 2 Dim.: Ø 12,2 mm 
Pos. 3 Name: Socket plate Quantity: 1 	Pos. 8 Name: Bolt 8,8 B Quantity: 1 Dim.: M12x75mm 	Pos. 14 Name: Nut 8 B Quantity: 3 Dim.: M10 	Pos. 20 Name: Spring washer Quantity: 5 Dim.: Ø 10,2 mm 
Pos. 4 Name: Right fish-plate Quantity: 1 	Pos. 9 Name: Bolt 8,8 B Quantity: 1 Dim.: M12x70mm 	Pos. 15 Name: Nut 8 B Quantity: 8 Dim.: M8 	Pos. 21 Name: Spring washer Quantity: 8 Dim.: Ø 8,2 mm 
	Pos. 10 Name: Bolt 8,8 B Quantity: 3 Dim.: M10x90mm 	Pos. 16 Name: Plain washer Quantity: 2 Dim.: Ø 13 mm 	Pos. 22 Name: Ball cover Quantity: 1 

### NOTE

After install the towbar you should get adequate note in registration book (at authorised service station). The car should be equipped with:

- Indicators
- Tow mirrors

After 1000km of exploitation check all bolts and nuts. The ball of towbar must be always kept clear and conserve with a grease.



## PPUH AUTO-HAK S.J.

Produkcja Zaczepów Kulowych  
Henryk i Zbigniew Nejman  
76-200 SŁUPSK ul. Słoneczna 16K  
tel/fax (059) 8-414-414; 8-414-413  
E-mail: [office@autohak.com.pl](mailto:office@autohak.com.pl)  
[www.autohak.com.pl](http://www.autohak.com.pl)

### Towing hitch (without electrical set)

Class: **A50-X** Cat. no. **S008**

Designed for:

Manufacturer: **FIAT**

Model: **SEICENTO SPORTING**

Type: **3 doors**

produced since 1998 till 2003

Technical data:

**D-value: 2,94 kN**

maximum trailer weight: **400 kg**

maximum vertical cup load: **28 kg**

Approval number acc. to regulations EKG/ONZ 55.01: **E20-55R-01 1132**

### Foreword

This towbar is designed according to rules of safety traffic regulations. The towing hitch is a safety component and can be install only by qualified personnel. Any alteration or conversion of the towing hitch is prohibited and would lead to cancellation of design certification. Remove insulating compound and underseal from vehicle (if present) in the area of the matting surfaces of the towing hitch. The vehicle manufacturer's specifications regarding trailer load and max. vertical cup load are decisive for driving whereat values for the towing hitch cannot be exceeded.

*D-value formula:*

$$\frac{\text{Max trailer weight [kg]} \times \text{Max vehicle weight [kg]}}{\text{Max trailer weight [kg]} + \text{Max vehicle weight [kg]}} \times \frac{9,81}{1000} = D \text{ [kN]}$$