

# AUTO-HAK Sp. z o.o.

ul. Słoneczna 16K 76-200 SŁUPSK  
POLAND

tel/fax +48 59 8 414 414; +48 59 8 414 413

e-mail: [office@autohak.com.pl](mailto:office@autohak.com.pl)

[www.autohak.com.pl](http://www.autohak.com.pl)





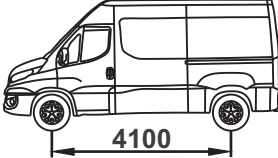

# AUTO-HAK





## FIAT IVECO DAILY VI MODEL 35

Nr kat.
<b>R63</b>

  tylko koła podwójne  
double wheels only 



 2014 →



 E20-55R-01 5440

 23,0 kN

 R=3500 kg

 S=280 kg

  2h





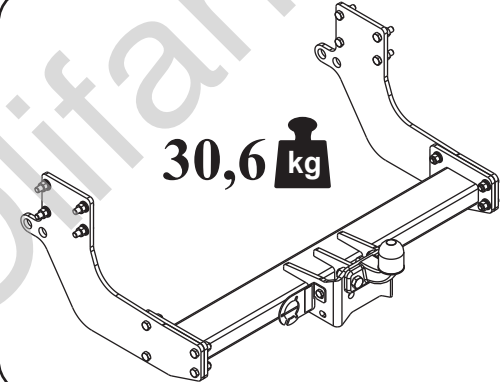

30,6 kg











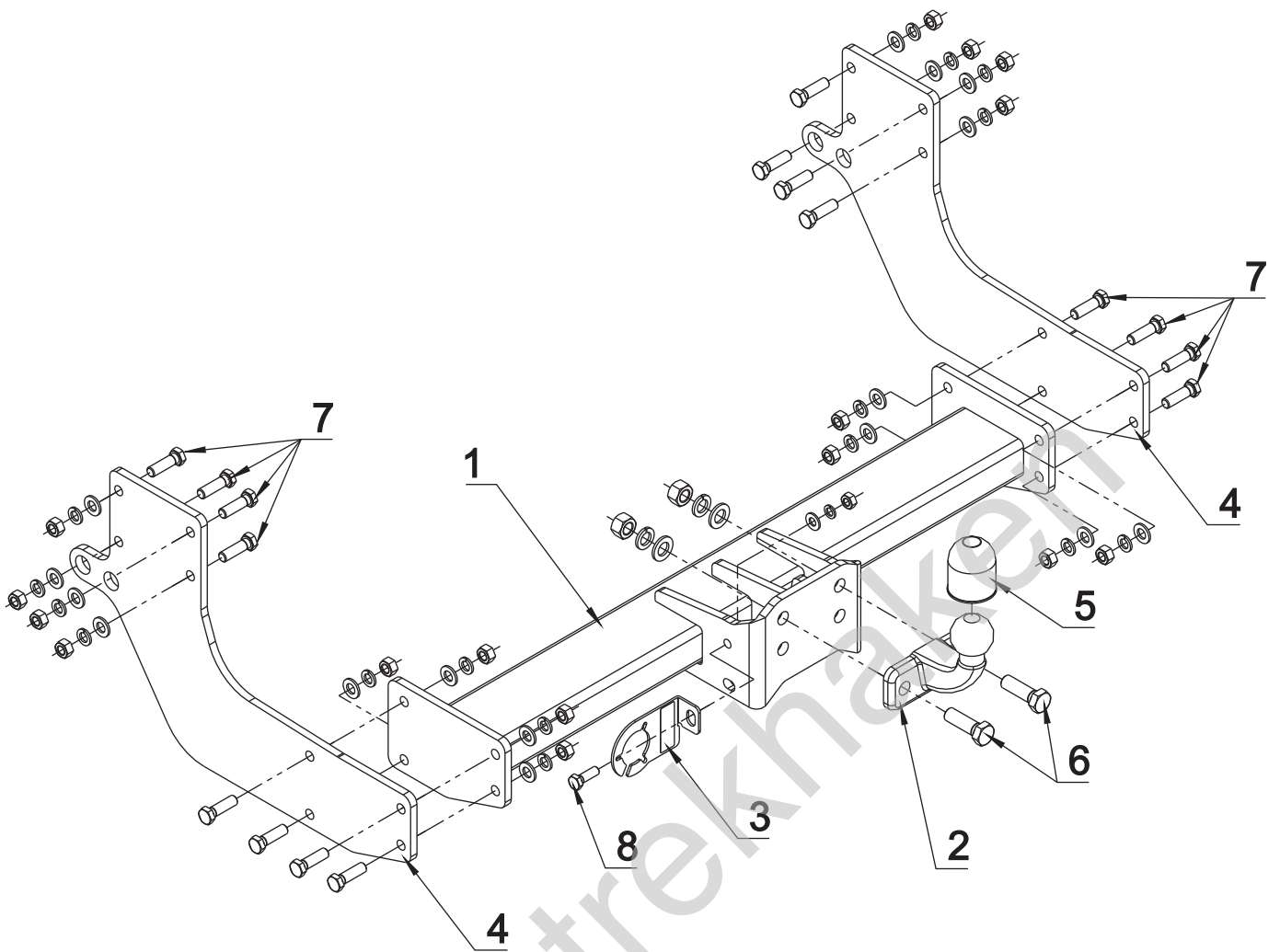

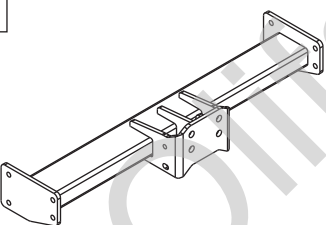
FULL VERSION INSTRUCTION

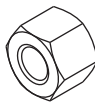
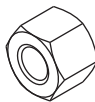
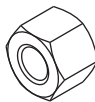
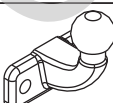

śruba	Nm	M6	M8	M10	M12	M14	M16
klasa 8.8		9,9	24	48	83	132	200
klasa 10.9		14	34	67	117	185	285

 0 km →  1000 km

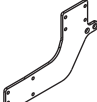

	<b>x 1</b>		<b>6</b> M16x50	<b>x 2</b>
			<b>7</b> M12x40	<b>x 16</b>
			<b>8</b> M10x30	<b>x 1</b>
			<b>9</b> $\varnothing$ 17	<b>x 2</b>
	<b>x 1</b> Art.nr-KL1R63		<b>10</b> $\varnothing$ 13	<b>x 16</b>
			<b>11</b> $\varnothing$ 10.5	<b>x 1</b>
	<b>x 1</b> Art.nr-BL1R63		<b>12</b> $\varnothing$ 16.3	<b>x 2</b>
			<b>13</b> $\varnothing$ 12.2	<b>x 16</b>
	<b>x 2</b>		<b>14</b> $\varnothing$ 10.2	<b>x 1</b>
			<b>15</b> M16	<b>x 2</b>
	<b>x 1</b>		<b>16</b> M12	<b>x 16</b>
			<b>17</b> M10	<b>x 1</b>
	<b>x 1</b>			
	<b>x 1</b>			
	<b>x 2</b>			
	<b>x 1</b>			

