

## FITTING INSTRUCTION

Clamp mark in acc. with		Cables joining
ISO	PN	
1	L	Left directional lights
2	+	Rear fog lights
3	31	Ground
4	R	Right directional lights
5	58R	Right side parking lights
6	54	Stoplights
7	58L	Left side parking lights

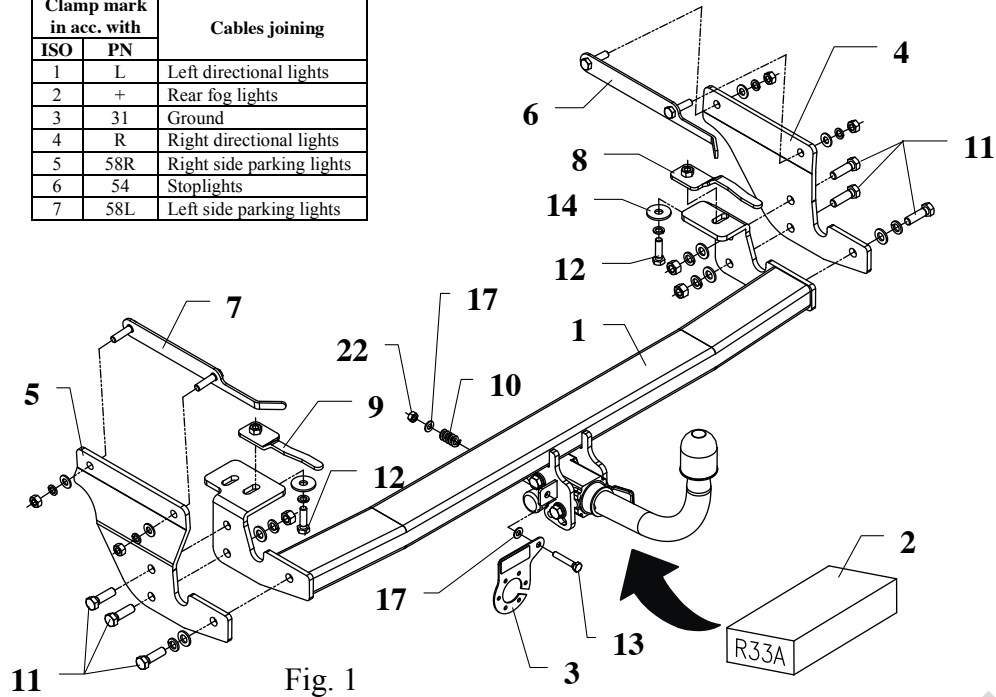

Fig. 1

This towing hitch is designed to assembly in following car:  
**FIAT STILO ESTATE**, produced since 11.2002 till 2008, catalogue number **R33A** and is prepared to tow trailers max total weight **1300 kg** and max vertical load **60 kg**.

### The instruction of the assembly

1. Disassemble the bumper and metal support.
2. Drill the holes  $\varnothing 11$  outside the left and right chassis members (see the fig.2).
3. Position the left bracket (pos. 5) to the drilled holes in the left chassis member and element (pos. 4) to the drilled holes in the right one and fix it together with fish-plates (pos. 6 and 7) (Attention!!! Fish-plates 6 and 7 put inside the chassis members).
4. Position the main bar of towing hitch (pos. 1) and fix it using bolts M12x40mm (pos. 11) and together with jibs (pos. 8 and 9) using bolts M10x35mm (pos. 12).
5. Cut the metal support according to the fig. 3 and then reassemble it.
6. Cut the bumper according to the fig. 4 and then reassemble it.
7. Tighten all nuts and bolts according to the torque shown in the table.
8. Place tow-ball (pos. 2) according to supplied instruction.

9. Fix the socket plate (pos. 3) as shown on the drawing.
10. Connect to the electric wires according to the instructions of the car.
11. Complete the paint cover of towing hitch (during the mounting paint cover could be destroyed).

Torque settings for nuts and bolts (8,8):  
**M 8 - 25 Nm**                      **M 10 - 55 Nm**  
**M 12 - 85 Nm**                      **M 14 - 135 Nm**

### NOTE

After install the towing hitch you should get adequate note in registration book (at authorised service station).The car should be equipped with:

- Indicators
- Tow mirrors

After 1000km check all bolts and nuts. The ball of towing hitch must be always kept clear and conserve with a grease.

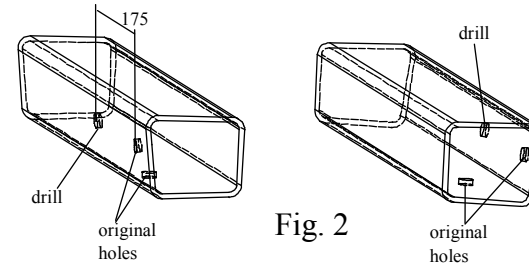

Fig. 2

Fig. 3

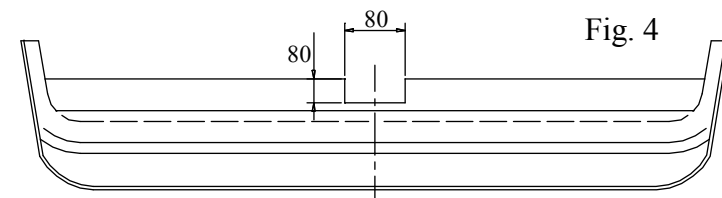
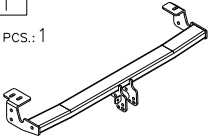



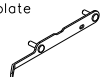



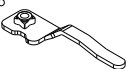



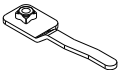











Fig. 4

## Towing hitch accessories:

Pos. 1 Main bar PCS.: 1 	Pos. 6 Right fish-plate PCS.: 1 	Pos. 12 Bolt 8,8 B M10x35 PCS.: 2 	Pos. 18 Spring washer ø12,2mm PCS.: 6 
	Pos. 7 Left fish-plate PCS.: 1 	Pos. 13 Bolt 8,8 B M8x45mm PCS.: 1 	Pos. 19 Spring washer ø10,2mm PCS.: 6 
Pos. 2 Tow-ball (mounting set) PCS.: 1 	Pos. 8 Right jib PCS.: 1 	Pos. 14 Plain washer ø30xø10,5x2,5mm PCS.: 2 	Pos. 20 Nut 8 B M12 PCS.: 4 
Pos. 3 Socket plate PCS.: 1 	Pos. 9 Left jib PCS.: 1 	Pos. 15 Plain washer ø13mm PCS.: 6 	Pos. 21 Nut 8 B M10 PCS.: 4 
Pos. 4 Right bracket PCS.: 1 	Pos. 10 Spring PCS.: 1 	Pos. 16 Plain washer ø10,5mm PCS.: 6 	Pos. 22 Nut 8 B M8 PCS.: 1 
Pos. 5 Left bracket PCS.: 1 	Pos. 11 Bolt 8,8 B M12x40 PCS.: 6 	Pos. 17 Plain washer ø8mm PCS.: 2 	



**PPUH AUTO-HAK Sp.J.**

Produkcja Zaczepów Kulowych  
Henryk i Zbigniew Nejman  
76-200 SŁUPSK ul. Słoneczna 16K  
tel/fax (059) 8-414-414; 8-414-413  
E-mail: [office@autohak.com.pl](mailto:office@autohak.com.pl)  
[www.autohak.com.pl](http://www.autohak.com.pl)

## Towing hitch (without electrical set)

Class: **A50-X** Cat. no. **R33A**

Designed for:

Manufacturer: **FIAT**

Model: **STILO**

Type: **ESTATE**

produced since 11.2002 till 2008

Technical data:

**D-value: 8,1 kN**

maximum trailer weight: **1300 kg**

maximum vertical cup load: **60 kg**

**Approval number acc. to regulations EKG/ONZ 55.01: E20-55R-01 4440**

## Foreword

This towing hitch is designed according to rules of safety traffic regulations. The towing hitch is a safety component and can be install only by qualified personnel. Any alteration or conversion of the towing hitch is prohibited and would lead to cancellation of design certification. Remove insulating compound and underseal from vehicle (if present) in the area of the matting surfaces of the towing hitch.

The vehicle manufacturer's specifications regarding trailer mass and max. vertical cup mass are decisive for driving whereat values for the towing hitch cannot be exceeded.

*D-value formula:*

$$\frac{\text{Max trailer weight [kg]} \times \text{Max vehicle weight [kg]} \times 9,81}{\text{Max trailer weight [kg]} \times \text{Max vehicle weight [kg]} \times 100} = D \text{ [kN]}$$