

AUTO-HAK Sp. z o.o.

ul. Słoneczna 16K 76-200 SŁUPSK
POLAND

tel/fax +48 59 8 414 414; +48 59 8 414 413

e-mail: office@autohak.com.pl

www.autohak.com.pl



AUTO-HAK



CITROEN XSARA PICASSO
5D., VAN (N68)

Cat. no:

P12A



01.2000 → 2010



E20-55R-01 4193



7,49 kN



2h



R=1300 kg



S=80 kg



15,8 kg

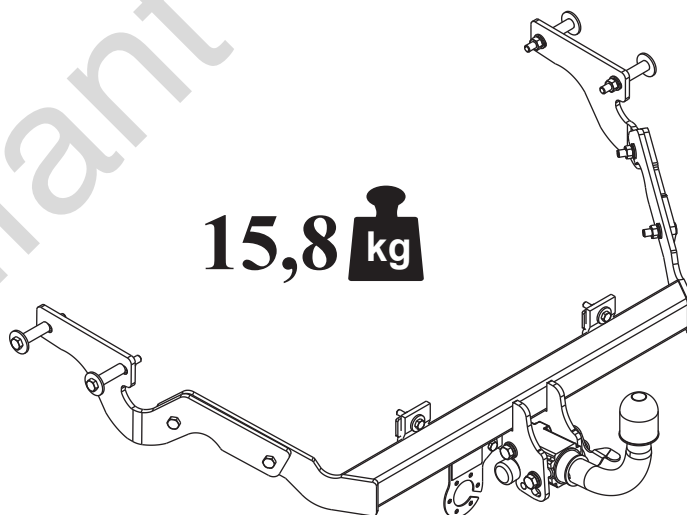

M6 - 11 Nm
M10 - 50 Nm
M14 - 138 Nm

M8 - 25 Nm
M12 - 87 Nm
M16 - 210 Nm









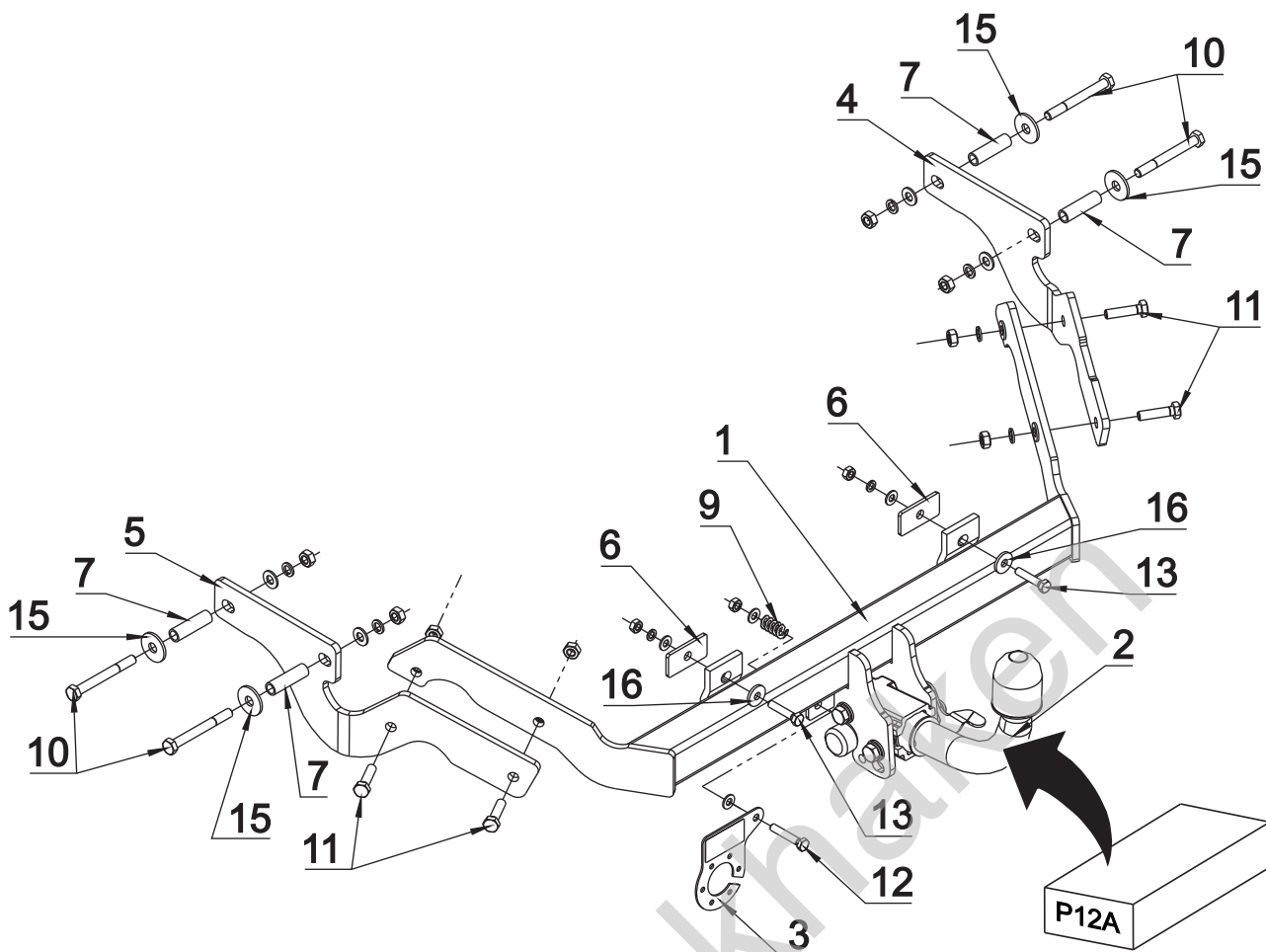

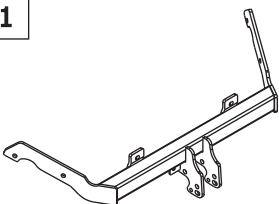

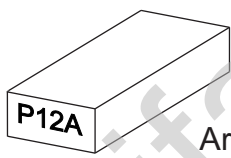



0 km →



1000 km

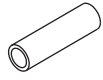

	x1		10	M10x90	4
			11	M10x40	4
 Art.nr-KL1P12A	x1		12	M8x45	1
			13	M8x40	2
 Art.nr-BL1P12A	x1		14	∅ 10.5	8
			15	∅ 30x∅10.5x2.5 10 (DIN 9021)	4
	x1		16	∅ 24x∅8.5x2 8 (DIN 9021)	2
			17	∅ 8.5	4
	x1		18	∅ 10.2	8
			19	∅ 8.2	2
 ∅15x2mm L=52mm	x2		20	M10	8
			21	M8	3
	x4				
	x1				
	x1				

