

FITTING INSTRUCTION

Clamp mark in acc. with		Cables joining
ISO	PN	
1	L	Left directional lights
2	+	Rear fog lights
3	31	Ground
4	R	Right directional lights
5	58R	Right side parking lights
6	54	Stoplights
7	58L	Left side parking lights

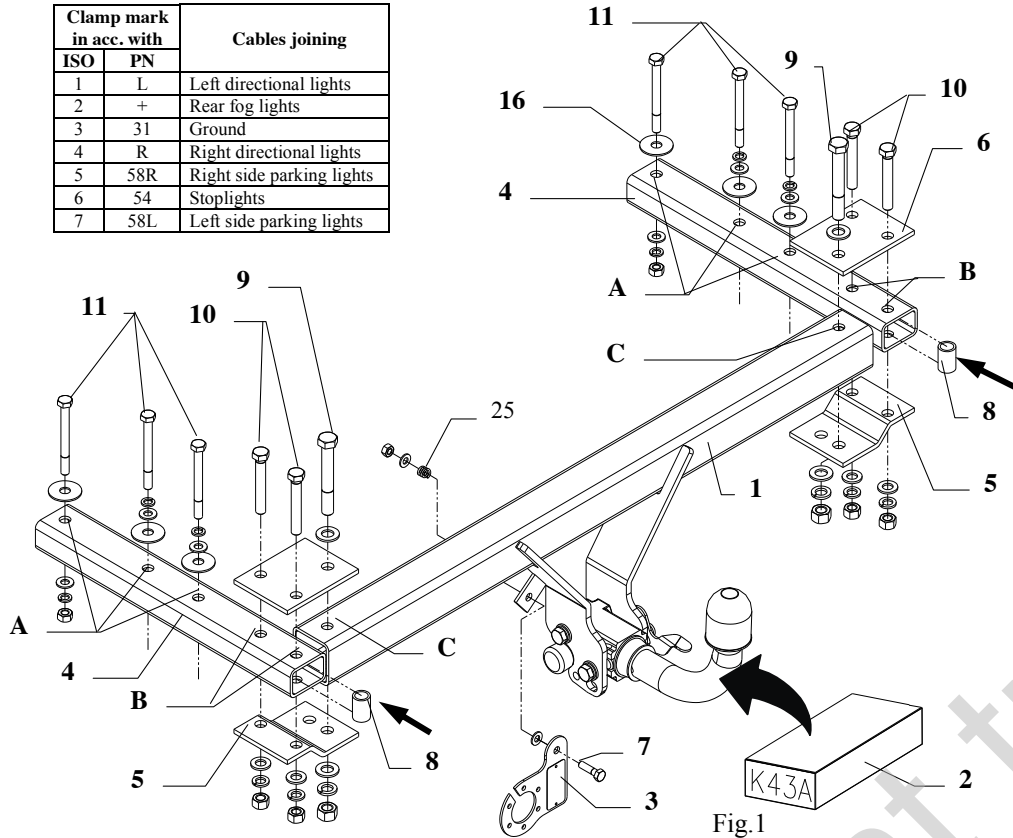

Fig.1

This towbar is designed to assembly in following cars:
VW P VW PASSAT B5 4 MOTION, 4 doors, Kombi, (3B), only 4x4, produced since 09.1996 till 09.2000, **VW PASSAT B5 MOTION, 4 doors, Kombi, (3BG), only 4x4**, produced since 10.2000 till 08.2005, catalogue no. **K43A** and is prepared to tow trailers max total weight **2200 kg** and max vertical load **85 kg**.

From manufacturer

Thank you for buying our product. Their reliability has been confirmed in many tests. Reliability of towbar depends also on correct assembly and right operation. For this reasons we kindly ask to read carefully this instruction and apply to hints.

The towbar should be install in points described by a car producer.

The instruction of the assembly

1. Disassemble bumper and metal reinforcement (not used any more).
2. To chassis members slip elements (pos. 4) in this way, so holes (pos. A) agree with holes in a car and fix using bolts M10x100mm – pos. 11 (loosely) – see figure.
3. To elements (pos. 4) through holes (pos. B) fix elements pos. 5 and 6 and sleeve (pos. 8) using bolts M12x80mm – pos. 10 (loosely).
4. To in this way prepared elements fix the main bar of towbar (pos. 1) and screw through holes (pos. C) with bolts M14x100mm (pos. 9).
5. Tighten all bolts according to the torque shown in the table.
6. Assemble the bumper after cut out his fragment in lower part.
7. Fix body of the automat according to supplied instruction.
8. Fix the socket plate (pos. 3) as shown on the drawing.
9. Connect electric wires of 7-poles socket according to the instruction of the car. (Recommend to make at authorized service station)
10. Complete the paint coating damaged during installation.

Torque settings for nuts and bolts (8,8):

M6 - 11 Nm	M8 - 25 Nm	M10 - 50 Nm
M12 - 87 Nm	M14 - 138 Nm	M16 - 210 Nm











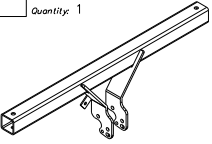





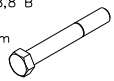
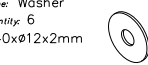

NOTE

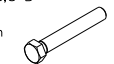
After install the towbar you should get adequate note in registration book (at authorised service station). The car should be equipped with:

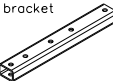
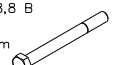
- Indicators
- Tow mirrors

After 1000km of exploitation check all bolts and nuts. The ball of towbar must be always kept clear and conserve with a grease.

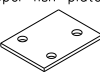
Towbar accessories:

Pos. 1 Name: Main bar Quantity: 1 	Pos. 7 Name: Bolt 8,8 B Quantity: 1 Dim.: M8x30mm 	Pos. 14 Name: Nut 8 B Quantity: 2 Dim.: M10 	Pos. 22 Name: Spring washer Quantity: 2 Dim.: Ø14,2 mm 
	Pos. 8 Name: Distance sleeve Quantity: 2 	Pos. 15 Name: Nut 8 B Quantity: 1 Dim.: M8 	Pos. 23 Name: Spring washer Quantity: 4 Dim.: Ø12,2 mm 
Pos. 2 Name: Tow ball Quantity: 1 	Pos. 9 Name: Bolt 8,8 B Quantity: 2 Dim.: M14x100mm 	Pos. 16 Name: Washer Quantity: 6 Dim.: Ø40xØ12x2mm 	Pos. 24 Name: Spring washer Quantity: 6 Dim.: Ø10,2 mm 
Pos. 3 Name: Socket plate Quantity: 1 	Pos. 10 Name: Bolt 8,8 B Quantity: 4 Dim.: M12x80mm 	Pos. 17 Name: Plain washer Quantity: 4 Dim.: Ø15 mm 	Pos. 25 Name: Spring Quantity: 1 
Pos. 4 Name: Side bracket Quantity: 2 	Pos. 11 Name: Bolt 8,8 B Quantity: 6 Dim.: M10x100mm 	Pos. 19 Name: Plain washer Quantity: 4 Dim.: Ø13 mm 	
Pos. 5 Name: The bottom fish-plate Quantity: 2 	Pos. 12 Name: Nut 8 B Quantity: 2 Dim.: M14 	Pos. 20 Name: Plain washer Quantity: 6 Dim.: Ø10,5 mm 	
Pos. 6 Name: The upper fish-plate Quantity: 2 	Pos. 13 Name: Nut 8 B Quantity: 4 Dim.: M12 	Pos. 21 Name: Plain washer Quantity: 2 Dim.: Ø8,3 mm 	

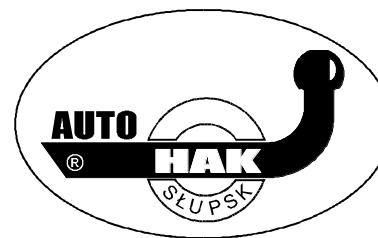

PPUH AUTO-HAK Sp. J.

Produkcja Zaczepów Kulowych
Henryk & Zbigniew Nejman
76-200 SŁUPSK ul. Słoneczna 16K
tel/fax (059) 8-414-414; 8-414-413
E-mail: office@autohak.com.pl
www.autohak.com.pl

Towing hitch (without electrical set)

Class: **A50-X** Cat. no. **K43A**

Designed for:

VW P VW PASSAT B5 4 MOTION

Type: **4 doors, Kombi, (3B), only 4x4**

– produced since 09.1996 till 09.2000

VW PASSAT B5 MOTION

Type: **4 doors, Kombi, (3BG), only 4x4**

– produced since 10.2000 till 08.2005

Approval number according to Directive 94/20/EC: **e20*94/20*1159*00**

Technical data:

D-value: 11,3 kN

maximum trailer weight: **2200 kg**

maximum vertical cup load: **85 kg**

Foreword

This towbar is designed according to rules of safety traffic regulations. The towing hitch is a safety component and can be install only by qualified personnel. Any alteration or conversion of the towing hitch is prohibited and would lead to cancellation of design certification. Remove insulating compound and underseal from vehicle (if present) in the area of the matting surfaces of the towing hitch.

The vehicle manufacturer's specifications regarding trailer load and max. vertical cup load are decisive for driving, and values for the towing hitch cannot be exceeded.

D-value formula:

$$\frac{\text{Max trailer weight [kg]} \times \text{Max vehicle weight [kg]}}{\text{Max trailer weight [kg]} + \text{Max vehicle weight [kg]}} \times \frac{9,81}{1000} = D \text{ [kN]}$$