

# AUTO-HAK Sp. z o.o.

ul. Słoneczna 16K 76-200 SŁUPSK  
POLAND

tel/fax +48 59 8 414 414; +48 59 8 414 413

e-mail: [office@autohak.com.pl](mailto:office@autohak.com.pl)

[www.autohak.com.pl](http://www.autohak.com.pl)



# AUTO-HAK

## VOLKSWAGEN:

GOLF IV, 3/5 D, ~~4 Motion~~ 08.1997 → 10.2003

GOLF IV VARIANT (Kombi), ~~4 Motion~~ 07.1999 → 07.2006

BORA, 4 D, ~~4 Motion~~ 10.1998 → 05.2005

BORA VARIANT (Kombi), ~~4 Motion~~ 05.1999 → 05.2005

Cat. no:

# H07A

## SKODA :

OCTAVIA I, 02.1997 → 12.2010  
5D, kombi Tour (1U), tylko 2WD

## AUDI:

A3, 09.1996 → 04.2003  
3/5D (8L), ~~Quattro~~, ~~S~~



# 1,5h

**e20**

**e20\*94/20\*0788\*00**

**D**

**8,62 kN**



**R=1600 kg**



**S=75 kg**

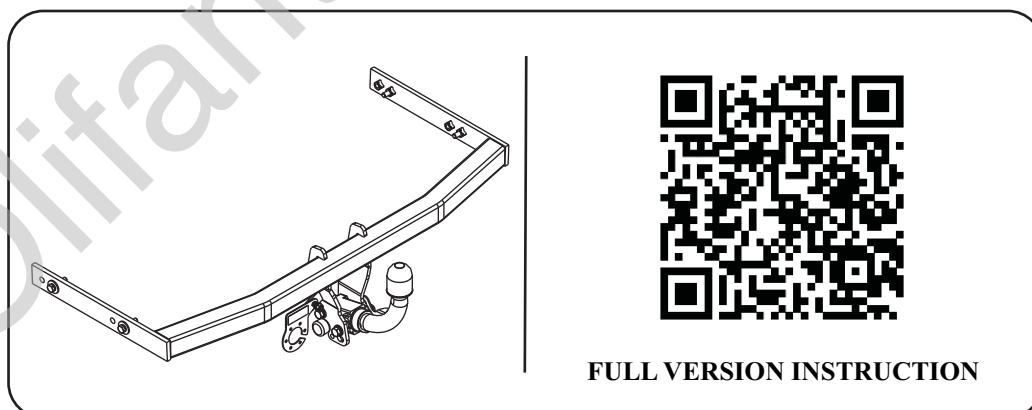

FULL VERSION INSTRUCTION







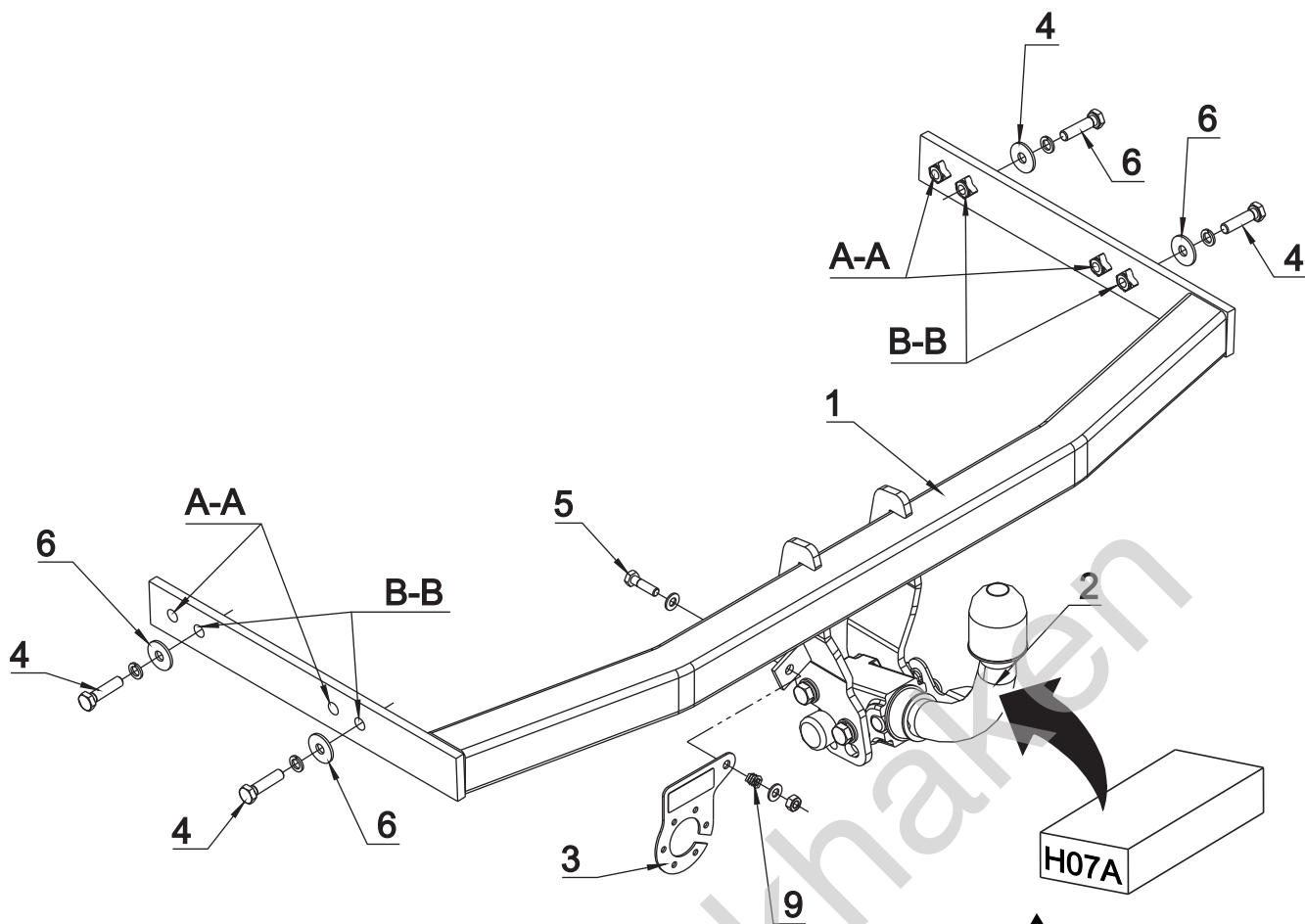

śruba Nm	M6	M8	M10	M12	M14	M16
klasa 8.8	9,9	24	48	83	132	200
klasa 10.9	14	34	67	117	185	285

0 km → 1000 km

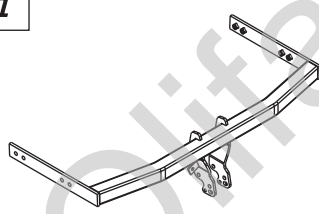

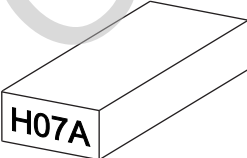
- \*A-A Volkswagen Golf IV Kombi
- \*B-B Volkswagen Golf IV, Volkswagen Bora, Skoda Octavia 5D, Skoda Octavia Kombi, Audi A3, excl. Quattro



	x1		4	M10x40	x4
			5	M8x45	x1
	x1		6	∅ 30x∅10.5x2.5 10 DIN 9021	x4
			7	∅ 10.2	x4
			8	M8	x1
	x1	9		x1	
Art.nr-KL1H07A		Art.nr-BL1H07A			

