

FITTING INSTRUCTION

Clamp mark in acc. with		Cables joining
ISO	PN	
1	L	Left directional lights
2	+	Rear fog lights
3	31	Ground
4	R	Right directional lights
5	58R	Right side parking lights
6	54	Stoptlights
7	58L	Left side parking lights

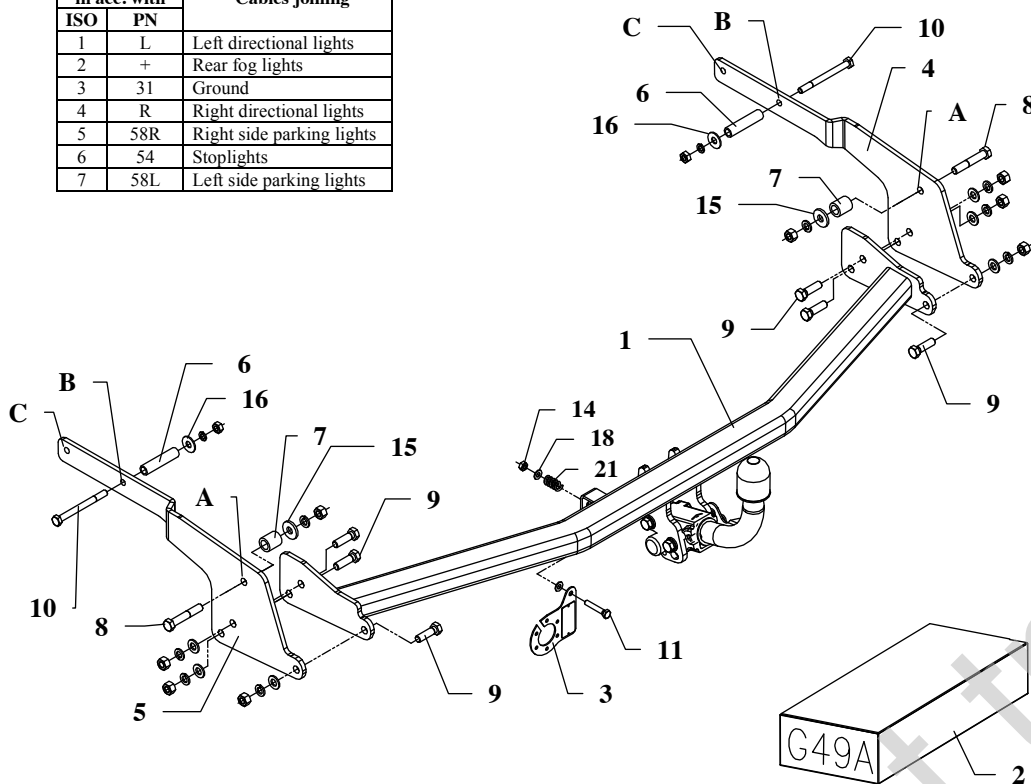

Fig. 1

This towing hitch is designed to assembly in following cars: **RENAULT ESPACE and GRAND ESPACE, 5 doors, VAN**, produced since 10.2002 till 12.2014, catalogue number **G49A** and is prepared to tow trailers max total weight **2000 kg** and max vertical mass **80 kg**.

From manufacturer

Thank you for buying our product. Their reliability has been confirmed in many tests. Reliability of towing hitch depends also on correct assembly and right operation. For this reasons we kindly ask to read carefully this instruction and apply to hints.

The towing hitch should be installed in points described by a car producer.

The instruction of the assembly

1. Disassemble rear wheels and spare wheel.
2. Disassemble a bumper.
3. Disassemble plastic covers and cut out fragments according to figure 2.
4. Put side brackets (pos. 4 and 5) to chassis members and fix loosely through holes A and B (**Espace**) or A and C (**Grand Espace**) using bolts M10x110mm (pos. 10) and M12x70mm (pos. 8). Use distance sleeves pos. 6 and 7 and big washers pos. 15 and 16 as shown on the figure.
5. Between installed side brackets put main bar of the towbar (pos. 1) and fix it using bolts M12x40mm (pos. 9).
6. Fix body of the automat using bolts M12x25mm from accessories. Place tow-ball according to supplied instruction.
7. Fix the socket plate (pos. 3) as shown on the drawing.
8. Tighten all bolts according to the torque shown in the table.
9. Reassemble all elements disassembled before.
10. Connect electric wires of 7-poles socket according to the instruction of the car. (Recommend to make at authorized service station).
11. Complete paint layer damaged during installation.

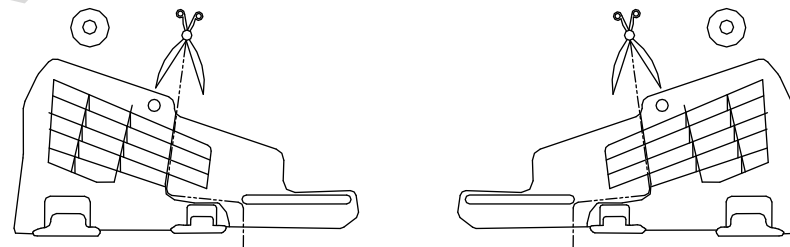

Fig. 2

Torque settings for nuts and bolts (8,8):	
M 8 - 25 Nm	M 10 - 55 Nm
M 12 - 85 Nm	M 14 - 135 Nm











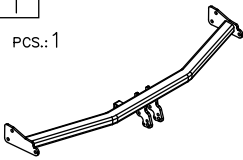





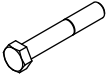

NOTE

After installation of the towing hitch you should get adequate note in registration book (at authorised service station).The car should be equipped with:

- Indicators
- Tow mirrors

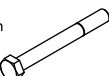
After 1000km of exploitation check all bolts. The ball of hitch must be always kept clear and conserve with a grease.

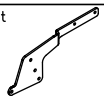
Part list:

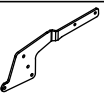
Pos. 1 Main bar  PCS.: 1	Pos. 6 Distance sleeve $\phi 17,2 \times 2,35 \text{mm}$ $L=74 \text{mm}$  PCS.: 2	Pos. 12 Nut 8 B M12  PCS.: 8	Pos. 18 Plain washer $\phi 8,5 \text{mm}$  PCS.: 2
	Pos. 7 Distance sleeve $\phi 25 \times 4 \text{mm}$ $L=28 \text{mm}$  PCS.: 2	Pos. 13 Nut 8 B M10  PCS.: 2	Pos. 19 Spring washer $\phi 12,2 \text{mm}$  PCS.: 8
Pos. 2 Tow ball (mounting set)  PCS.: 1	Pos. 8 Bolt 8,8 B M12x70mm  PCS.: 2	Pos. 14 Nut 8 B M8  PCS.: 1	Pos. 20 Spring washer $\phi 10,2 \text{mm}$  PCS.: 2
	Pos. 9 Bolt 8,8 B M12x40mm  PCS.: 6	Pos. 15 Plain washer $\phi 37 \times \phi 13 \times 3 \text{mm}$  PCS.: 2	Pos. 21 Spring  PCS.: 1
Pos. 3 Socket plate  PCS.: 1	Pos. 10 Bolt 8,8 B M10x110mm  PCS.: 2	Pos. 16 Plain washer $\phi 30 \times \phi 10,5 \times 2,5 \text{mm}$  PCS.: 2	
Pos. 4 Right bracket 602x203mm  PCS.: 1	Pos. 11 Bolt 8,8 B M8x45mm  PCS.: 1	Pos. 17 Plain washer $\phi 13 \text{mm}$  PCS.: 6	
Pos. 5 Left bracket 602x203mm  PCS.: 1			



PPUH AUTO-HAK S.J.

Produkcja Zaczepów Kulowych
 Henryk & Zbigniew Nejman
 76-200 SŁUPSK ul. Słoneczna 16K
 tel/fax (059) 8-414-414; 8-414-413
 E-mail: office@autohak.com.pl
www.autohak.com.pl

Towing hitch (without electrical set)

Class: **A50-X** Cat. no. **G49A**

Designed for:

Manufacturer: **RENAULT**

Model: **ESPACE, GRAND ESPACE**

Type: **5 doors, VAN**

produced since 10.2002 till 12.2014

Technical data:

D-value: 11,3 kN

maximum trailer weight: **2000 kg**

maximum vertical cup mass: **80 kg**

Approval number according to Directive 94/20/EC: **e20*94/20*0148*00**

Foreword

This towing hitch is designed according to rules of safety traffic regulations. The towing hitch is a safety component and can be install only by qualified personnel. Any alteration or conversion of the towing hitch is prohibited and would lead to cancellation of design certification. Remove insulating compound and underseal from vehicle (if present) in the area of the matting surfaces of the towing hitch. The vehicle manufacturer's specifications regarding trailer load and max. vertical cup load are decisive for driving whereat values for the towing hitch cannot be exceeded.

D-value formula:

$$\frac{\text{Max trailer weight [kg]} \times \text{Max vehicle weight [kg]}}{\text{Max trailer weight [kg]} + \text{Max vehicle weight [kg]}} \times \frac{9,81}{1000} = D \text{ [kN]}$$