

# PPUH AUTO-HAK Sp.J.

Henryk i Zbigniew Nejman  
ul. Słoneczna 16K 76-200 SŁUPSK  
POLAND









tel/fax +48 59 8 414 414; +48 59 8 414 413

e-mail: [office@autohak.com.pl](mailto:office@autohak.com.pl)

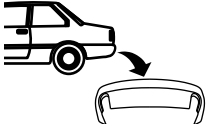
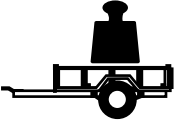

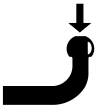
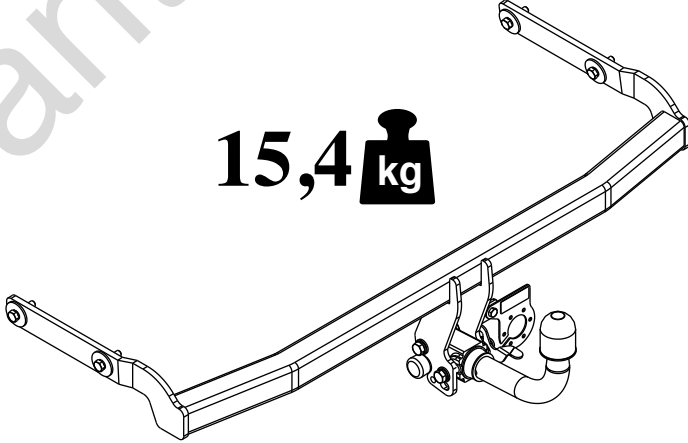





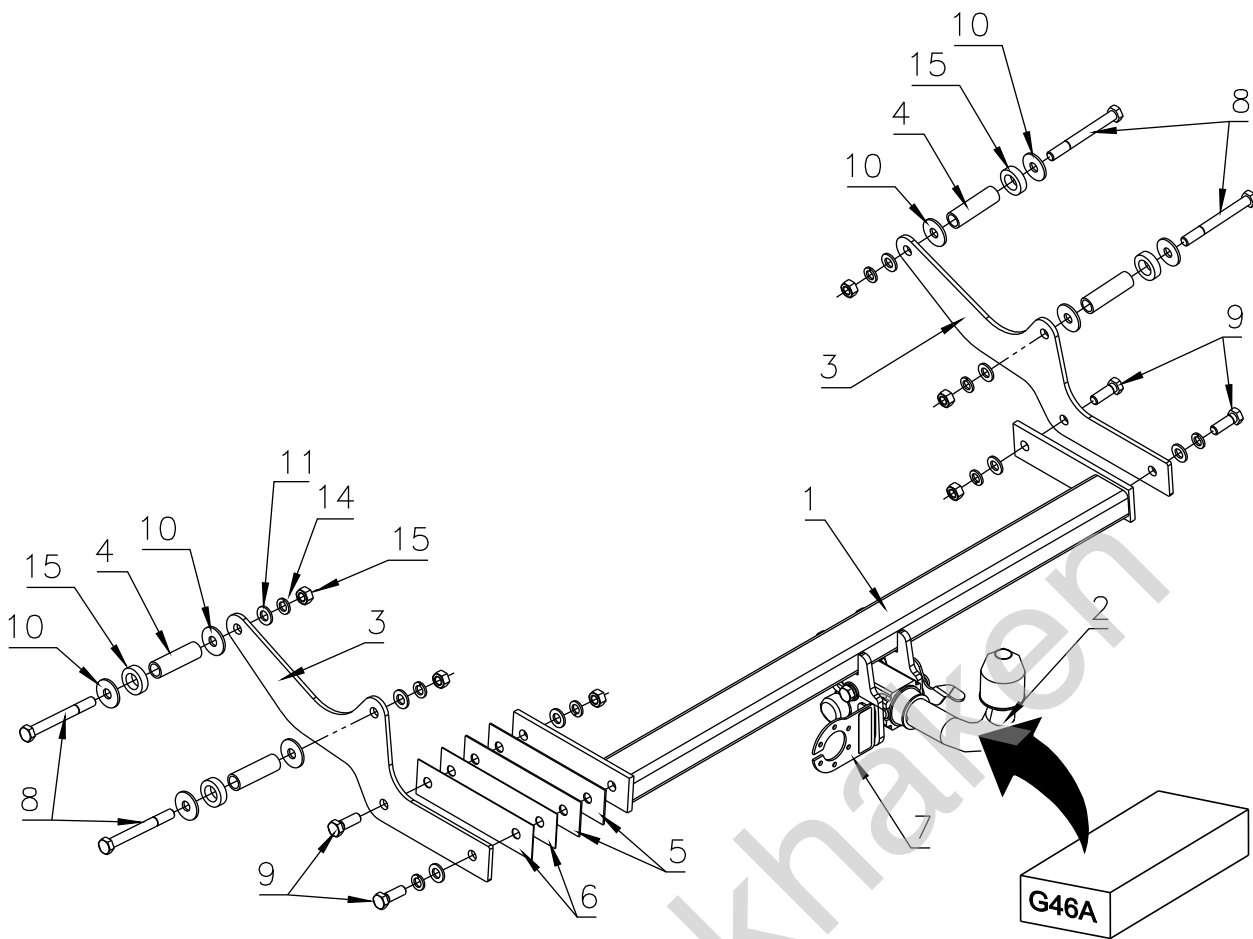

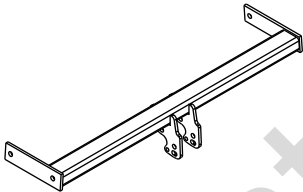
[www.autohak.com.pl](http://www.autohak.com.pl)

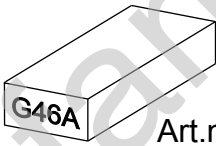

# AUTO-HAK

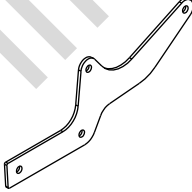
|  |   |   |
|--|---|---|
|                       | <b>RENAULT MEGANE II<br/>GRANDTOUR, KOMBI</b>   | <b>Cat. no:</b>   |
|                       | <b>09.2003 → 06.2009</b>  | <b>G46A</b>   |
| <b>e20</b>   | <b>e20*94/20*1054*00</b>  |  <b>2h</b>                             |
| <b>D</b>   | <b>7,74 kN</b>  |  <input checked="" type="checkbox"/>  |
|                      | <b>R=1350 kg</b>  |  <input checked="" type="checkbox"/> |
|                     | <b>S=75 kg</b>  |   |
| <br><b>15,4 kg</b> |   |   |
|                     | <b>M6 - 11 Nm</b>   | <b>M8 - 25 Nm</b>   |
|  | <b>M10 - 50 Nm</b>  | <b>M12 - 87 Nm</b>  |
|  | <b>M14 - 138 Nm</b>   | <b>M16 - 210 Nm</b>   |
|  |  <b>0 km</b> →  <b>1000 km</b> |   |

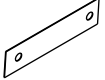
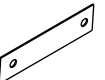
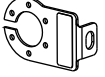

|          |   |           |   |   |           |
|----------|---|-----------|---|---|-----------|
| <b>1</b> |                    | <b>x1</b> |    | <b>8</b> M12x110  | <b>x4</b> |
|          |   |           |    | <b>9</b> M12x35   | <b>x4</b> |
|          |   |           |    | <b>10</b> $\varnothing$ 37x $\varnothing$ 13x3<br>13 (DIN 9021) | <b>x8</b> |
| <b>2</b> | <br>Art.nr-KL1G46A | <b>x1</b> |    | <b>11</b> $\varnothing$ 13                                      | <b>x8</b> |
|          |   |           |    | <b>12</b> $\varnothing$ 12.2                                    | <b>x8</b> |
| <b>3</b> |                    | <b>x2</b> |    | <b>13</b> M12   | <b>x6</b> |
|          |   |           |  | <b>14</b>   | <b>x1</b> |
|          |   |           |  | <b>15</b>   | <b>x4</b> |
| <b>4</b> |                    | <b>x4</b> |   |   |           |
| <b>5</b> | <b>1mm</b>         | <b>x2</b> |   |   |           |
| <b>6</b> | <b>2mm</b>         | <b>x2</b> |   |   |           |
| <b>7</b> |                    | <b>x1</b> |   |   |           |
|          | Art.nr-BL1G46A  |           |   |   |           |

