

AUTO-HAK Sp. z o.o.

ul. Słoneczna 16K 76-200 SŁUPSK
POLAND

tel/fax +48 59 8 414 414; +48 59 8 414 413

e-mail: office@autohak.com.pl

www.autohak.com.pl



AUTO-HAK



CHRYSLER PACIFICA

1 rura wydechowa
single exhaust pipe

Cat. no:

CH50



01.2003 → 11.2007

e20

e20*94/20*1260*00



2h

D

11,0 kN

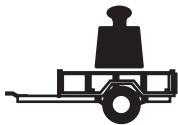

R=1800 kg



S=80 kg



21,3 kg

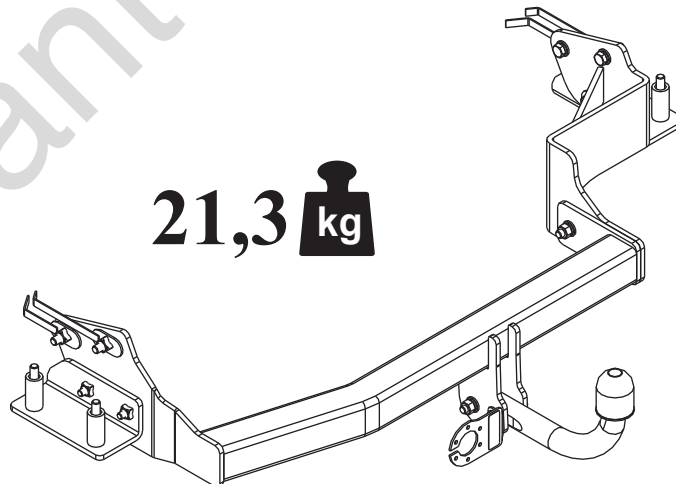

M6 - 11 Nm
M10 - 50 Nm
M14 - 138 Nm

M8 - 25 Nm
M12 - 87 Nm
M16 - 210 Nm









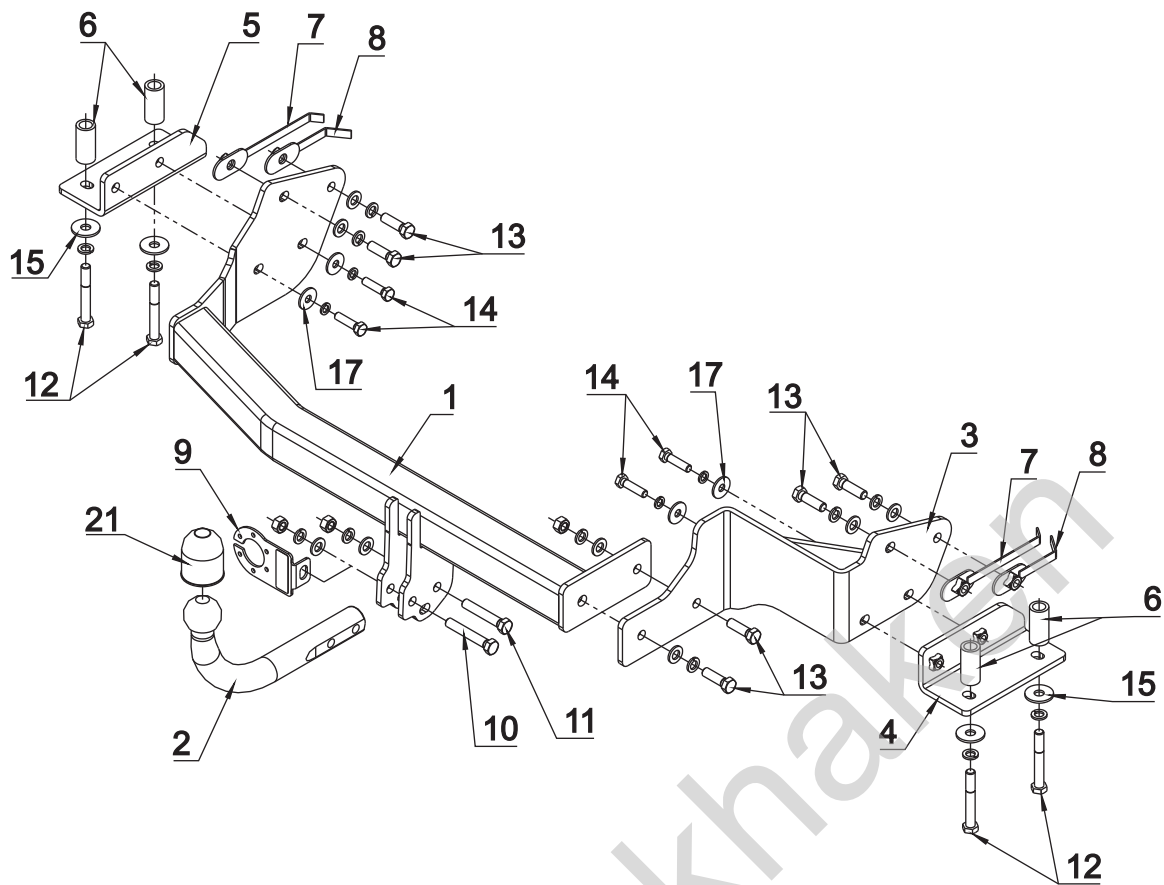

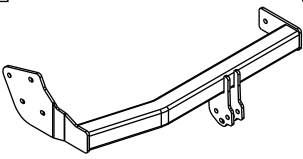

0 km →

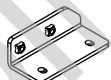
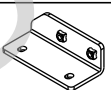

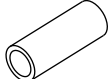
1000 km

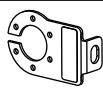

1		x 1		10	M12x75	x 1
				11	M12x70	x 1
				12	M12x85	x 4
				13	M12x40	x 6
				14	M10x40	x 4
2	 Art.nr-KL1CH50	x 1		15	∅ 37x∅13x3 13 (DIN 9021)	x 4
3		x 1		16	∅ 13	x 8
4		x 1		17	∅ 30x∅10.5x2.5 10 (DIN 9021)	x 4
5		x 1		18	∅ 12.2	x 12
				19	∅ 10.2	x 4
6	 ∅25x4mm, L=53mm	x 4		20	M12	x 3
			21			x 1
7		x 2				
8		x 2				
9	 Art.nr-BL1CH50	x 1				

