

AUTO-HAK Sp. z o.o.

ul. Słoneczna 16K 76-200 SŁUPSK
POLAND

tel/fax +48 59 8 414 414; +48 59 8 414 413

e-mail: office@autohak.com.pl

www.autohak.com.pl



AUTO-HAK

FORD TRANSIT/TOURNEO COURIER

(V769) dostawczy, osobowy

Nr kat.

C78V



12.2023 →



E20*55R02*6870



2h



7,85 kN



R=1200 kg



S=75 kg

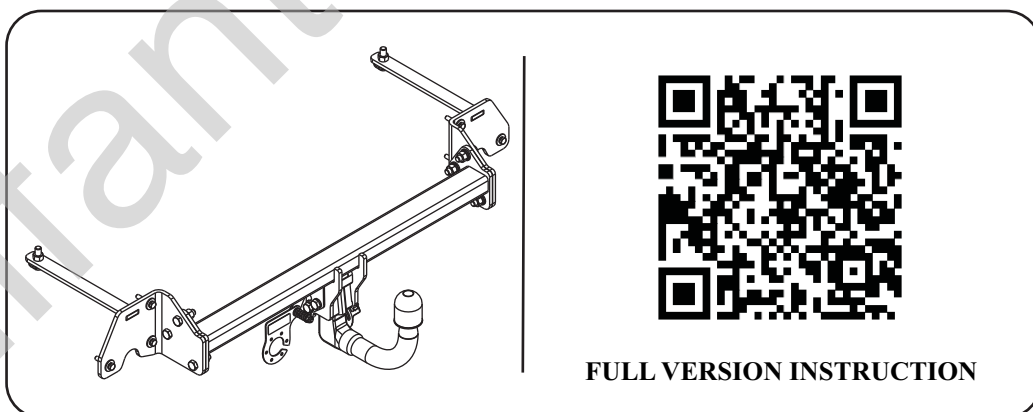

FULL VERSION INSTRUCTION



| śruba | Nm | M6 | M8 | M10 | M12 | M14 | M16 |
|------------|----|-----|----|-----|-----|-----|-----|
| klasa 8.8 | | 9,9 | 24 | 48 | 83 | 132 | 200 |
| klasa 10.9 | | 14 | 34 | 67 | 117 | 185 | 285 |









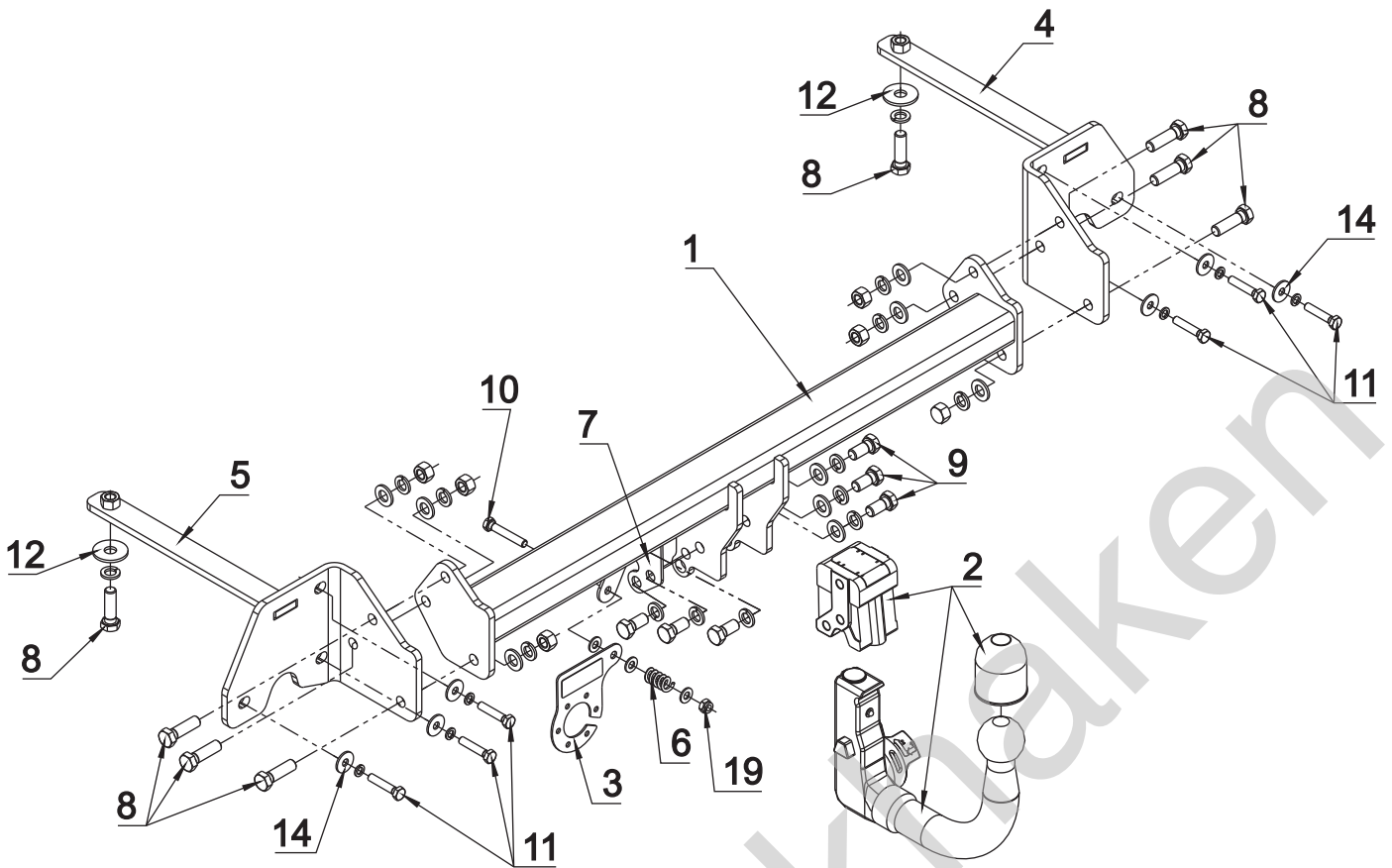

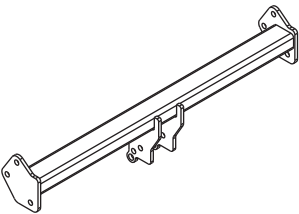

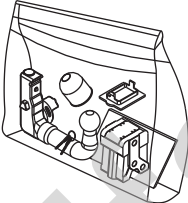

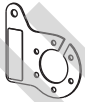

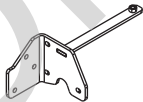
0 km →

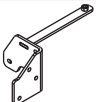

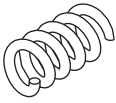
1000 km



| | | | | | |
|---|--|----|---|--|-----|
| 1 |  | x1 |  | 8 M12x40 | x8 |
| 2 |  Art.nr-KL1C78V | x1 |  | 9 M12x25 | x6 |
| | | | | 10 M8x50 | x1 |
| 3 |  Art.nr-BL12C78V | x1 |  | 11 M8x40 | x6 |
| | | | | 12 \varnothing 37x \varnothing 13x3 | 2 |
| 4 |  | x1 |  | 13 \varnothing 13 | x9 |
| | | | | 14 \varnothing 24x \varnothing 8.4x2 | 6 |
| 5 |  | x1 |  | 15 \varnothing 8.4 | x3 |
| | | | | 16 \varnothing 12.2 | x14 |
| 6 |  | x1 |  | 17 \varnothing 8.2 | x6 |
| | | | | 18 M12 | x6 |
| 7 |  | x1 |  | 19 M8 (DIN985) | x1 |

