

AUTO-HAK Sp. z o.o.

ul. Słoneczna 16K 76-200 SŁUPSK
POLAND

tel/fax +48 59 8 414 414; +48 59 8 414 413

e-mail: office@autohak.com.pl

www.autohak.com.pl



AUTO-HAK

FORD TRANSIT/TOURNEO COURIER

(V769) dostawczy, osobowy

Nr kat.

C78



12.2023 →



E20*55R02*6869



2h



7,85 kN



R=1200 kg



S=75 kg

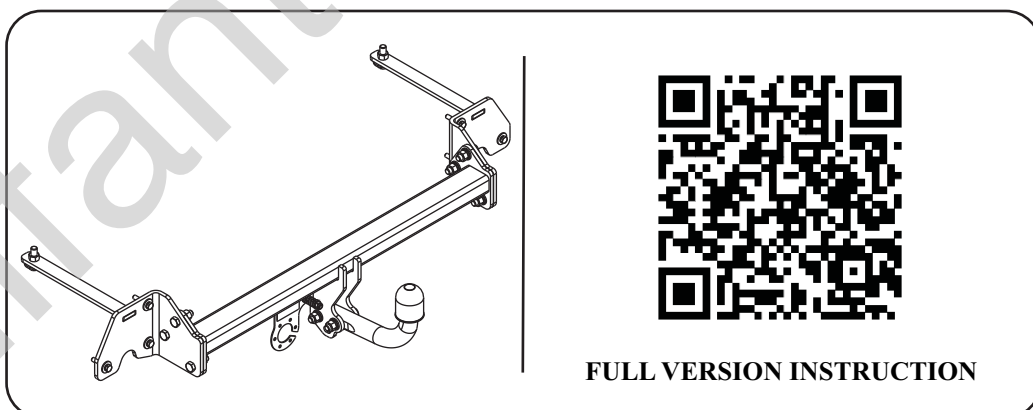

FULL VERSION INSTRUCTION



śruba	Nm	M6	M8	M10	M12	M14	M16
klasa 8.8		9,9	24	48	83	132	200
klasa 10.9		14	34	67	117	185	285









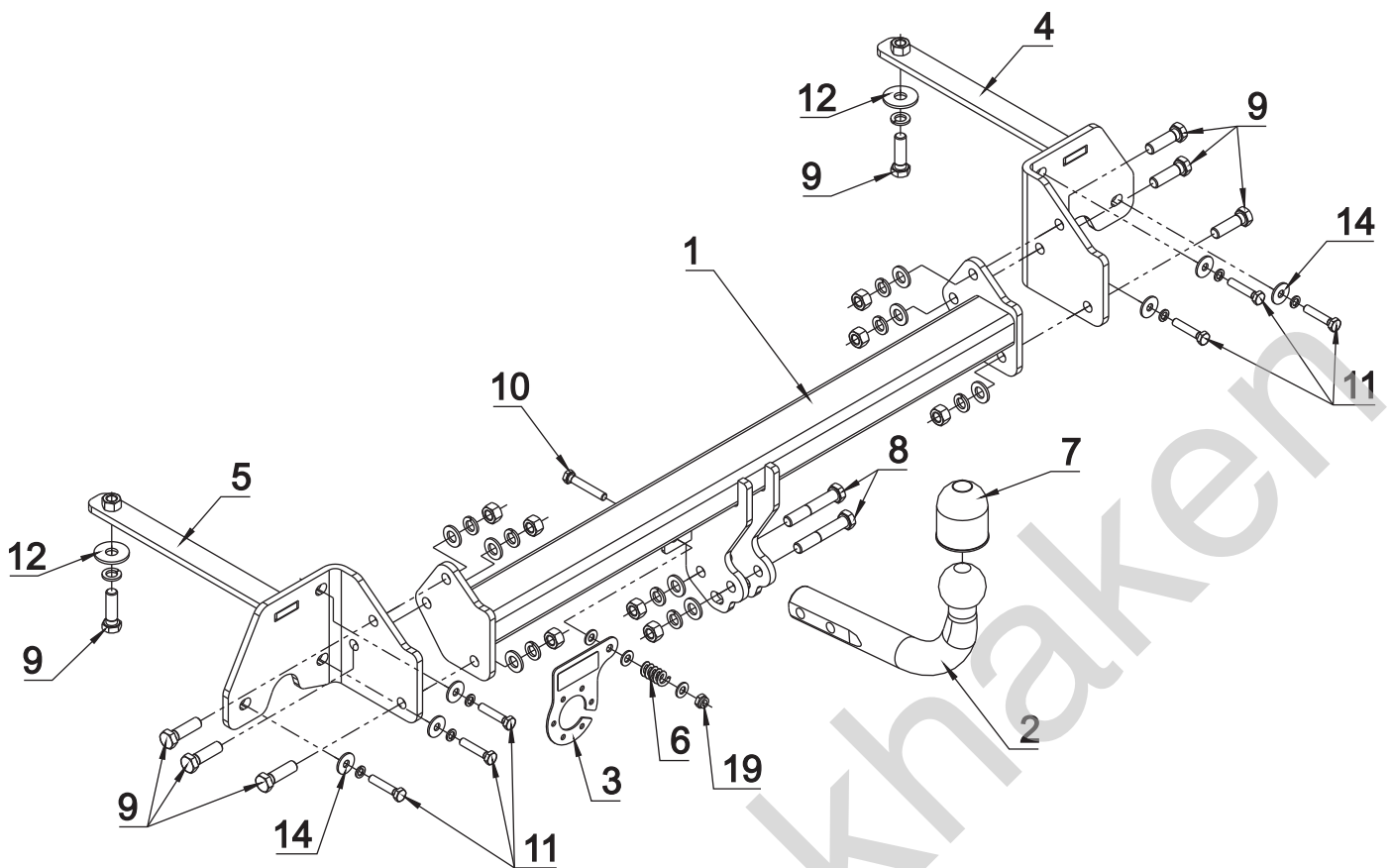

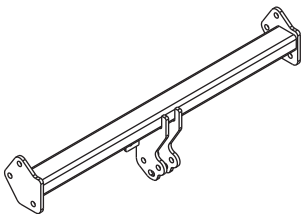

0 km →

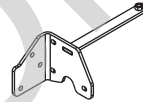

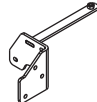
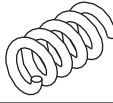
1000 km



1		x1		8	M12x70	x2
				9	M12x40	x8
				10	M8x50	x1
				11	M8x40	x6
				12	∅ 37x∅13x3	2
				13	DIN 9021	
2		x1		14	∅ 24x∅8.4x2	x8
	Art.nr-KL1C78			8	DIN 9021	6
3		x1		15	∅ 8.4	x3
	Art.nr-BL12C78			16	∅ 12.2	x10
4		x1		17	∅ 8.2	x6
5		x1		18	M12	x8
6		x1				
7		x1		19	M8 (DIN985)	x1

