

FITTING INSTRUCTION

Clamp mark in acc. with		Cables joining
ISO	PN	
1	L	Left directional lights
2	+	Rear fog lights
3	31	Ground
4	R	Right directional lights
5	58R	Right side parking lights
6	54	Stoptlights
7	58L	Left side parking lights

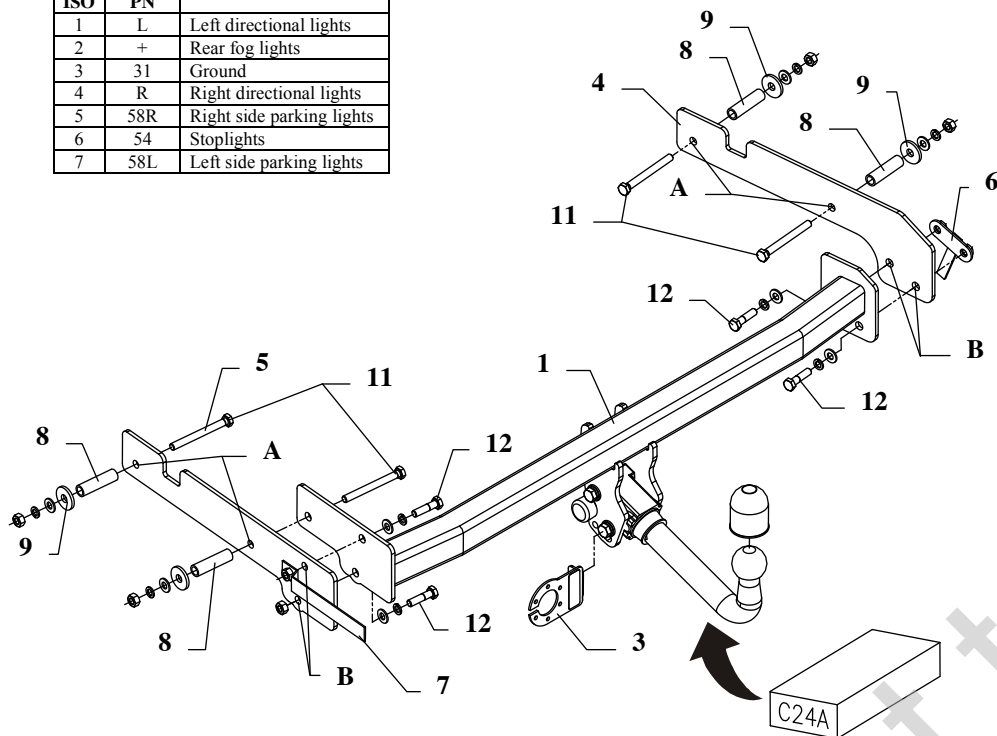

This towing hitch is designed to assembly in following cars:
FORD FIESTA COURIER delivery van (J3S, J5S), produced since 02.1996 till 12.2002, catalogue no. **C24A** and is prepared to tow trailers max total weight **900 kg** and max vertical load **50 kg**.

From manufacturer

Thank you for buying our product. Their reliability has been confirmed in many tests. Reliability of towing hitch depends also on correct assembly and right operation. For this reasons we kindly ask to read carefully this instruction and apply to hints.

The towing hitch should be install in points described by a car producer.

The instruction of the assembly

1. Disassemble the bumper. Take out the spare wheel.
2. Get lower the muffler from the last handle.
3. To the internal side of the chassis member (left side) apply the bracket of the towing hitch (pos. 5) that way, so its upper edge touch to the floor of the car. Then, through holes (pos. A) drill throughly with the bit $\phi 1$ mm. Then the external side of the chassis member drill with the bit $\phi 17,5$ mm. Through holes (pos. B) drill holes (only in one side of the chassis member) with the bit $\phi 1$ mm.
4. To the internal side of the chassis member (right side) apply the bracket of the towing hitch (pos. 4) that way, so its upper edge touch to the floor of the car. Then, through holes (pos. A) drill throughly with the bit $\phi 1$ mm. Then the external side of the chassis member drill with the bit $\phi 17,5$ mm. Through holes (pos. B) drill holes (only in one side of the chassis member).
5. Into so prepared holes $\phi 17,5$ mm insert distance sleeves L=63mm (pos. 8). Then fix using bolts M10x100mm (pos. 11). Use washers (pos. 9) as showed on the drawing.
6. To so prepared brackets (pos. 4 and 5) apply the main bar of the towing hitch (pos. 1) and fix with bolts M10x40mm (pos. 12). Use joint nuts (pos. 6), which one ought to insert through hole in the handle of the frame (right side). Use jib with the nut (pos. 7), which one ought to insert through hole in back piece (through this hole one install the bumper).
7. Install the bumper.
8. Fix body of the automat and place tow-ball according to supplied instruction. Note! Remember to place socket plate (pos. 3) as shown on the drawing 1.
9. Tighten all bolts according to the torque shown in the table.
10. Connect electric wires of 7-poles socket according to the instruction of the car. (Recommend to make at authorized service station).
11. Complete paint layer damaged during installation.

Torque settings for nuts and bolts (8,8):	
M 8 - 25 Nm	M 10 - 55 Nm
M 12 - 85 Nm	M 14 - 135 Nm





NOTE

After install the towing hitch you should get adequate note in registration book (at authorised service station). The car should be equipped with:

- Indicators
- Tow mirrors

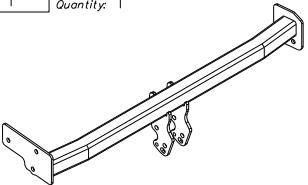
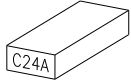
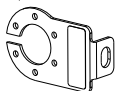
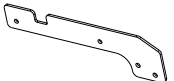
After 1000km check all bolts and nuts. The ball of towing hitch must be always kept clear and conserve with a grease.

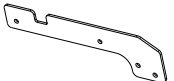
Towing hitch accessories:

Pos. 1	Name: Main bar Quantity: 1	Pos. 5	Name: Left bracket Quantity: 1	Pos. 10	Name: Plain washer Quantity: 8 Dim.: \varnothing 10,5 mm
		Pos. 6	Name: Jib with nuts 2xM10 Quantity: 1	Pos. 11	Name: Bolt 8,8 B Quantity: 4 Dim.: M10x100mm
Pos. 2	Name: Tow ball Quantity: 1	Pos. 7	Name: Jib with nut M10 Quantity: 1	Pos. 12	Name: Bolt 8,8 B Quantity: 4 Dim.: M10x40mm
		Pos. 8	Name: Distance sleeve Quantity: 4 Dim.: \varnothing 17,2x \varnothing 2,35mm L=63mm	Pos. 13	Name: Spring washer Quantity: 8 Dim.: \varnothing 10,2 mm
Pos. 3	Name: Socket plate Quantity: 1	Pos. 9	Name: Washer Quantity: 4 Dim.: \varnothing 35x \varnothing 12x4mm	Pos. 14	Name: Nut 8 B Quantity: 5 Dim.: M10
					
					



PPUH AUTO-HAK S.J.

Produkcja Haków Holowniczych
Henryk i Zbigniew Nejman
76-200 SŁUPSK ul. Słoneczna 16K
tel/fax (059) 8-414-414; 8-414-413
E-mail: office@autohak.com.pl
www.autohak.com.pl

Towing hitch (without electrical set)

Class: **A50-X** Cat. no. **C24A**
Designed for:
Manufacturer: **FORD**
Model: **FIESTA COURIER**
Type: **delivery van (J3S, J5S)**
produced since 02.1996 till 12.2002

Technical data:
D-value: 5,79 kN
maximum trailer weight: **900 kg**
maximum vertical cup load: **50 kg**

Approval number according to Directive 94/20/EC: **e20*94/20*0480*00**

Foreword

This towing hitch is designed according to rules of safety traffic regulations. The towing hitch is a safety component and can be install only by qualified personnel. Any alteration or conversion of the towing hitch is prohibited and would lead to cancellation of design certification. Remove insulating compound and underseal from vehicle (if present) in the area of the matting surfaces of the towing hitch. The vehicle manufacturer's specifications regarding trailer load and max. vertical cup load are decisive for driving whereat values for the towing hitch cannot be exceeded.

D-value formula:

$$\frac{\text{Max trailer weight [kg]} \times \text{Max vehicle weight [kg]}}{\text{Max trailer weight [kg]} + \text{Max vehicle weight [kg]}} \times \frac{9,81}{1000} = D \text{ [kN]}$$