

AUTO-HAK Sp. z o.o.

ul. Słoneczna 16K 76-200 SŁUPSK
POLAND

tel/fax +48 59 8 414 414; +48 59 8 414 413

e-mail: office@autohak.com.pl

www.autohak.com.pl



AUTO-HAK

BMW I (F40)

+M-pakiet

Nr kat.

B32



07.2019 →



E20*55R02*6450



1,5h

D

9,10 kN

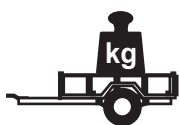

R=1650 kg



S=100 kg

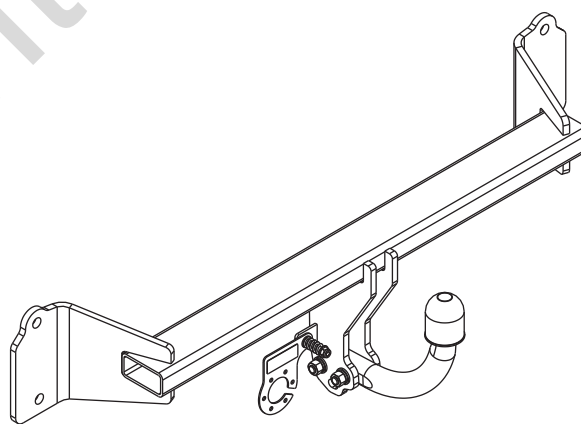

śruba	Nm	M6	M8	M10	M12	M14	M16
klasa 8.8		9,9	24	48	83	132	200
klasa 10.9		14	34	67	117	185	285









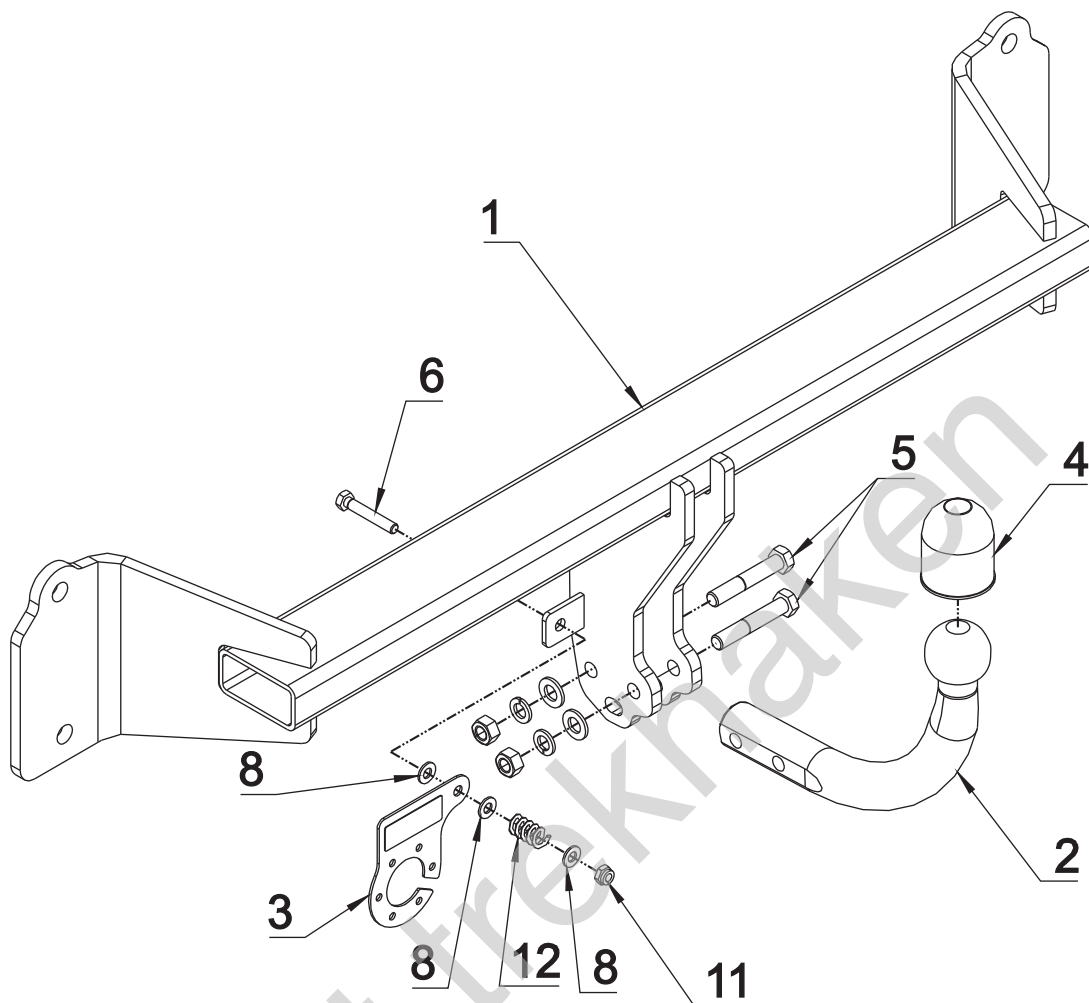

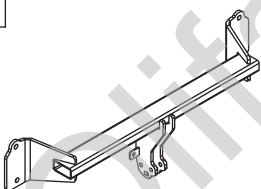

0 km →

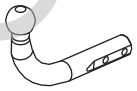

1000 km

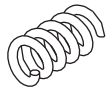

1		x1		5 M12x70	x2
				6 M8x50	x1
				7 \varnothing 13	x2
				8 \varnothing 8.4	x3
				9 \varnothing 12.2	x2
2		x1 Art.nr-KL1B32		10 M12	x2
3		x1 Art.nr-BL1B32		11 M 8 (DIN985)	x1
4		x1	12		x1

