

AUTO-HAK Sp. z o.o.

ul. Słoneczna 16K 76-200 SŁUPSK
POLAND

tel/fax +48 59 8 414 414; +48 59 8 414 413

e-mail: office@autohak.com.pl

www.autohak.com.pl



AUTO-HAK

ALFA ROMEO 156, 4D

~~GTA 3,2L 154W~~



11.1997 → 09.2005

Cat. no:

AL34

ALFA ROMEO 156, SPORTWAGON

Kombi ~~4x4, GTA 3,2L 154W~~

06.2000 → 05.2006



2h

E20

E20-55R-01 4289

D

8,66 kN



-

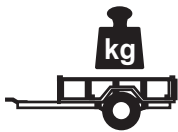

R=1600 kg



-



S=60 kg

21,1 kg

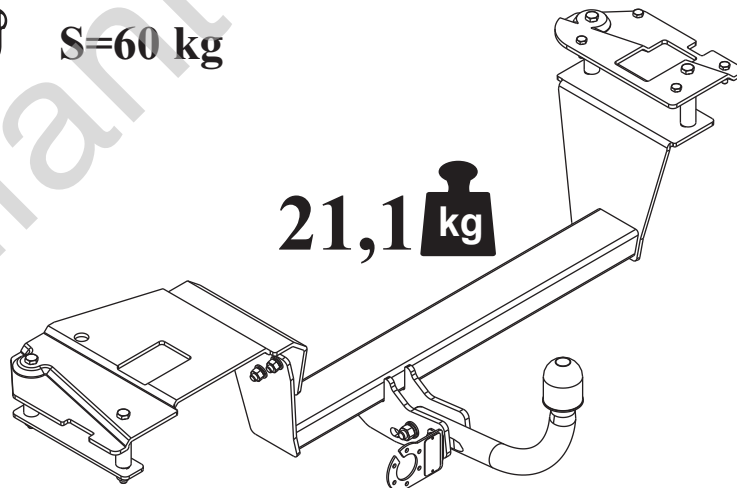

M6 - 11 Nm
M10 - 50 Nm
M14 - 138 Nm

M8 - 25 Nm
M12 - 87 Nm
M16 - 210 Nm









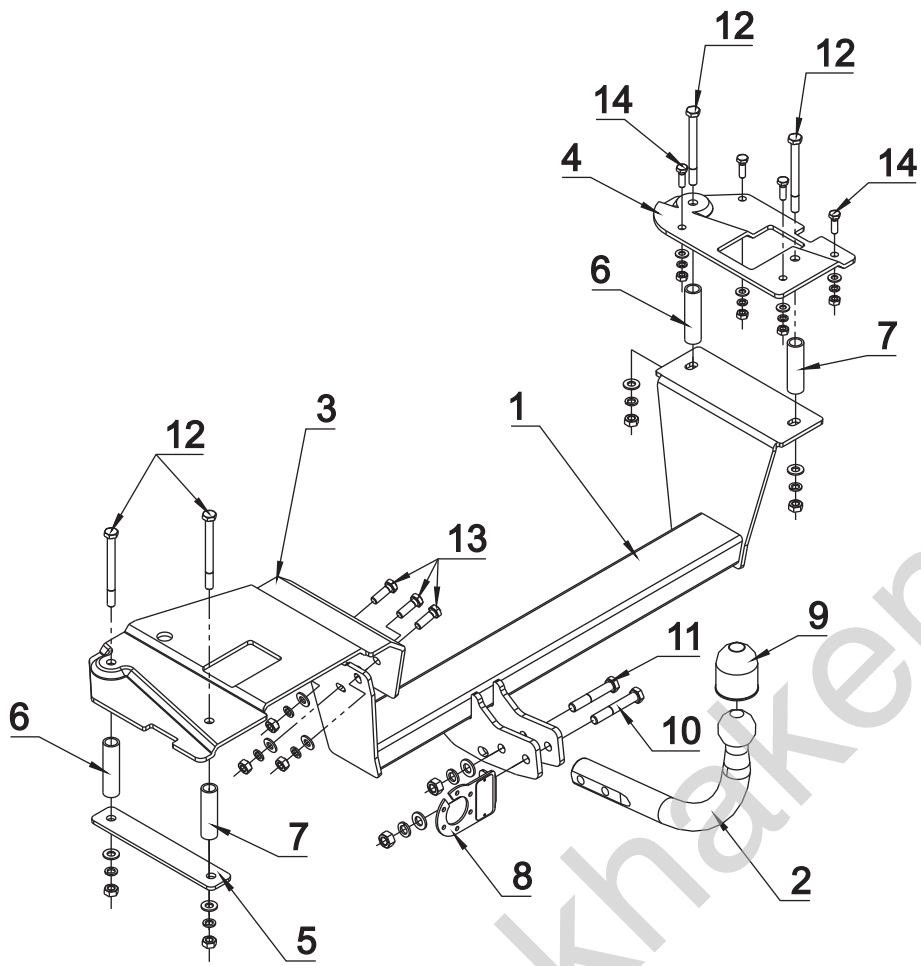

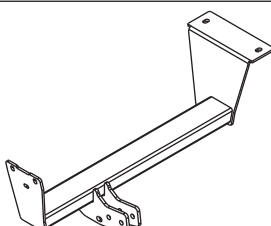

0 km →

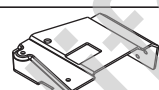
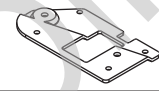

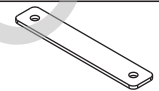
1000 km

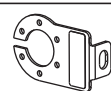

	x1		10 M12x75 x1
			11 M12x70 x1
			12 M10x110 x4
			13 M10x30 x3
			14 M8x25 x4
	x1 Art.nr-KL1AL34		15 \varnothing 13 x2
	x1		16 \varnothing 10.5 x7
	x1		17 \varnothing 8.5 x4
	x1		18 \varnothing 12.2 x2
	x2		19 \varnothing 10.2 x7
	x2	20 \varnothing 8.2 x4	
	x1 Art.nr-BL1AL34		21 M12 x2
	x1		22 M10 x7
			23 M8 x4
	\varnothing 21.3x2,65mm L=80mm		
	\varnothing 21.3x2,65mm L=74mm		

