

AUTO-HAK Sp. z o.o.

ul. Słoneczna 16K 76-200 SŁUPSK
POLAND

tel/fax +48 59 8 414 414; +48 59 8 414 413

e-mail: office@autohak.com.pl

www.autohak.com.pl



AUTO-HAK

AUDI A6

4D, Quattro (4G, C7), +S-line, ~~R86~~

04.2011 → 09.2014
 10.2014 → 05.2018

Cat. no:

A30

AUDI A6 AVANT

Kombi, Quattro (4G, C7), +S-line, ~~R86~~

09.2011 → 09.2014
 10.2014 → 05.2018

AUDI A7 Sportback

5D, Quattro, +S-line, ~~R86~~

09.2010 → 09.2014
 10.2014 → 04.2018



1h



E20

E20-55R-01 3686

D

12,6 kN



R=2500 kg



S=100 kg



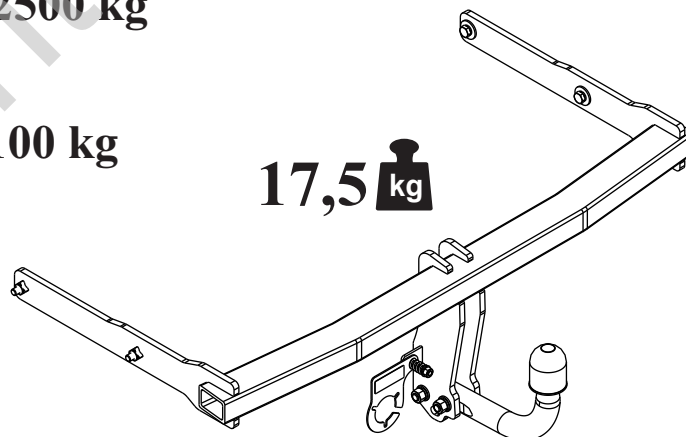





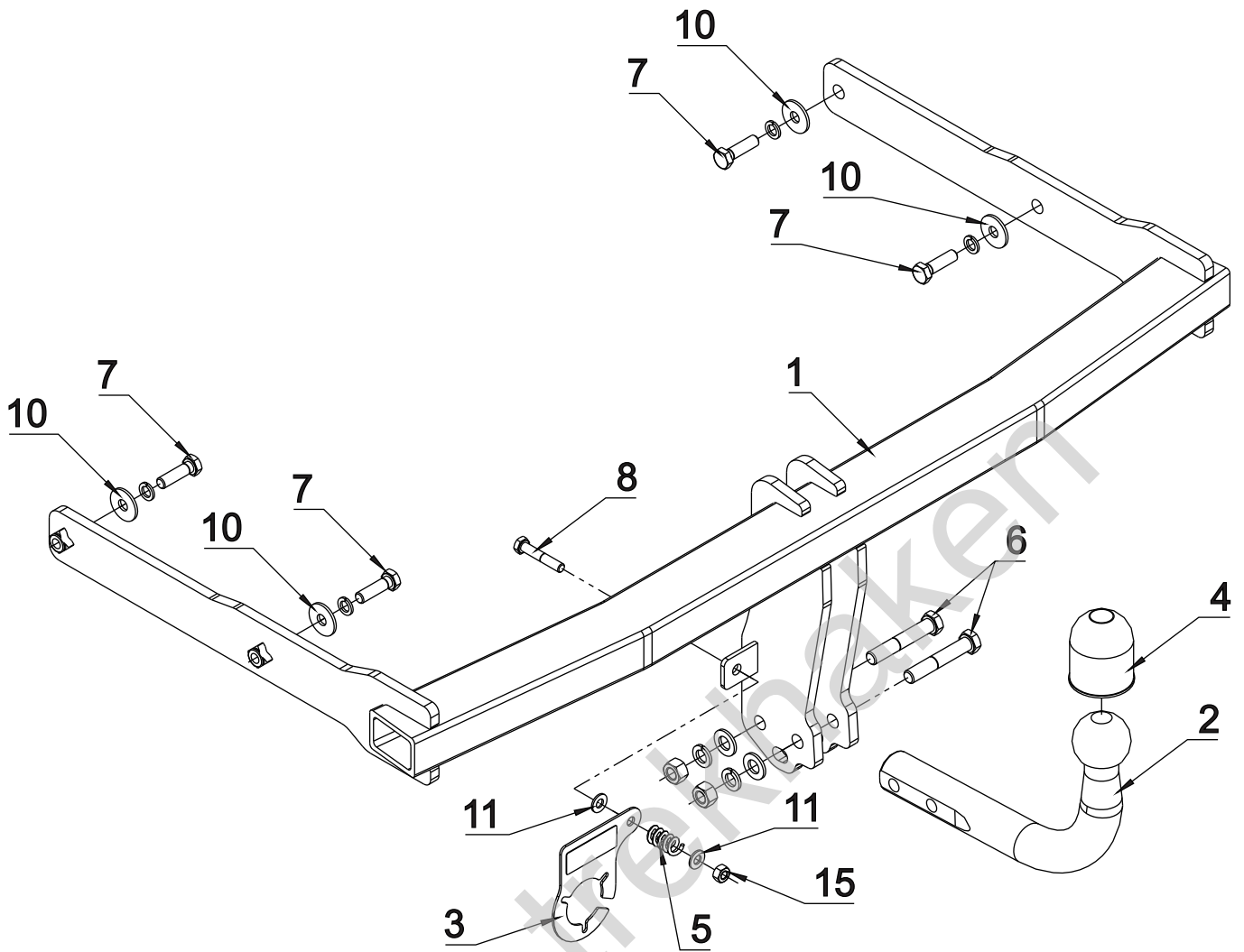

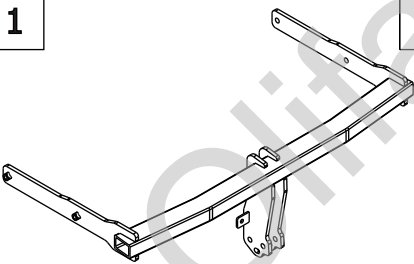

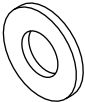
17,5 kg

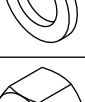

śruba Nm	M6	M8	M10	M12	M14	M16
klasa 8.8	9,9	24	48	83	132	200
klasa 10.9	14	34	67	117	185	285

0 km → 1000 km

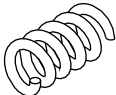

	x1		6 M12x70	x2
			7 M10x35	x4
			8 M8x45	x1
				9 ϕ 13
	x1 Art.nr-KL1A30		10 ϕ 30x ϕ 10.5x2.5	x4
			10 DIN 9021	x4
	x1 Art.nr-BL1A30		11 ϕ 8.5	x2
			12 ϕ 12.2	x2
	x1		13 ϕ 10.2	x4
				14 M12
	x1		15 M8	x1

