

AUTO-HAK Sp. z o.o.

ul. Słoneczna 16K 76-200 SŁUPSK
POLAND

tel/fax +48 59 8 414 414; +48 59 8 414 413

e-mail: office@autohak.com.pl

www.autohak.com.pl



AUTO-HAK



AUDI A6

4D, QUATTRO (4F, C6),
S-Line, ~~RS6~~

AUDI A6 AVANT

KOMBI QUATTRO (4F, C6),
S-Line, ~~RS6~~

Cat. no:

A21



4D - 05.2004 → 03.2011

KOMBI - 03.2005 → 08.2011



2h



E20-55R-01 4286

D

11,2 kN



R=2100 kg



S=85 kg

21,5 kg

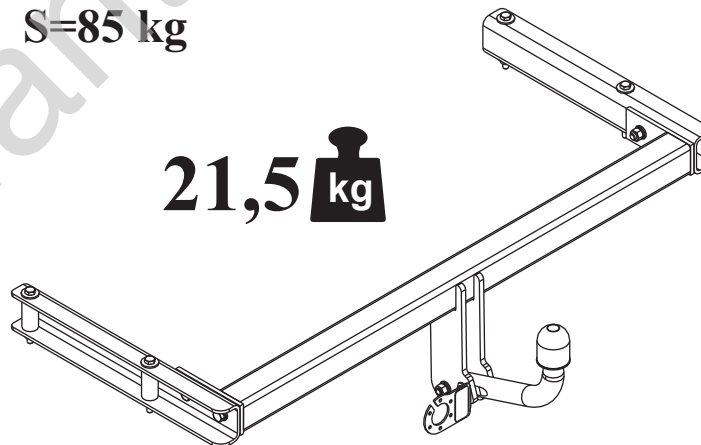

M6 - 11 Nm
M10 - 50 Nm
M14 - 138 Nm

M8 - 25 Nm
M12 - 87 Nm
M16 - 210 Nm









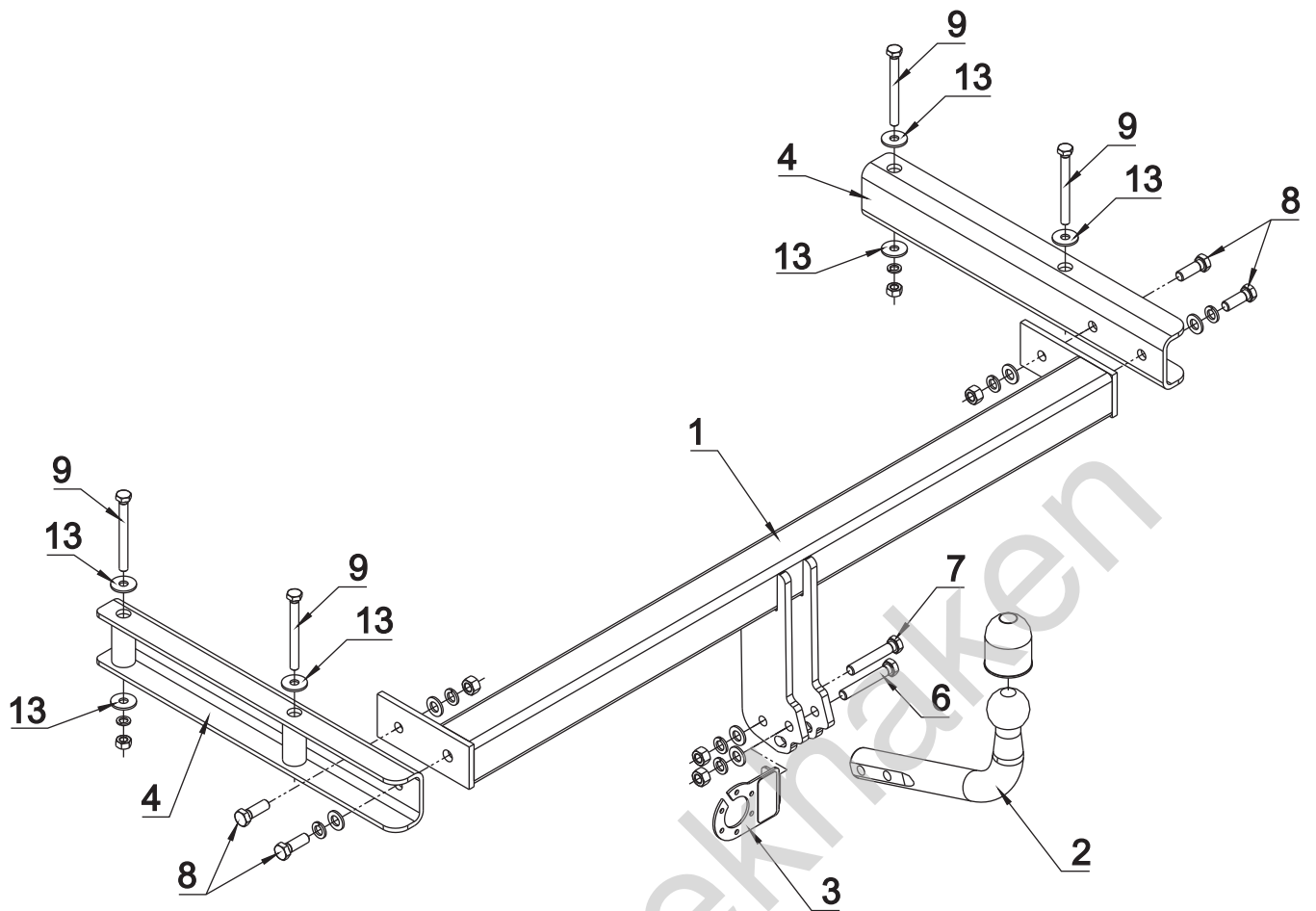

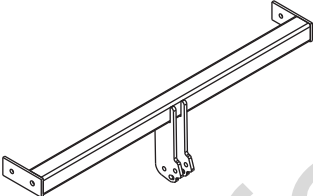



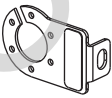

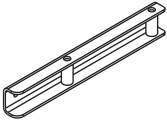
0 km →



1000 km



1		x 1		6 M12x75	x 1
2		x 1 Art.nr-KL1A21		7 M12x70	x 1
3		x 1 Art.nr-BL1A21		8 M12x35	x 4
4		x 2		9 M10x100	x 4
				10 M12	x 4
				11 M10	x 2
				12 \varnothing 13	x 6
				13 \varnothing 30x \varnothing 10.5x2.5 10 (DIN 9021)	x 6
				14 \varnothing 12.2	x 6
				15 \varnothing 10.2	x 2

