

## FITTING INSTRUCTION

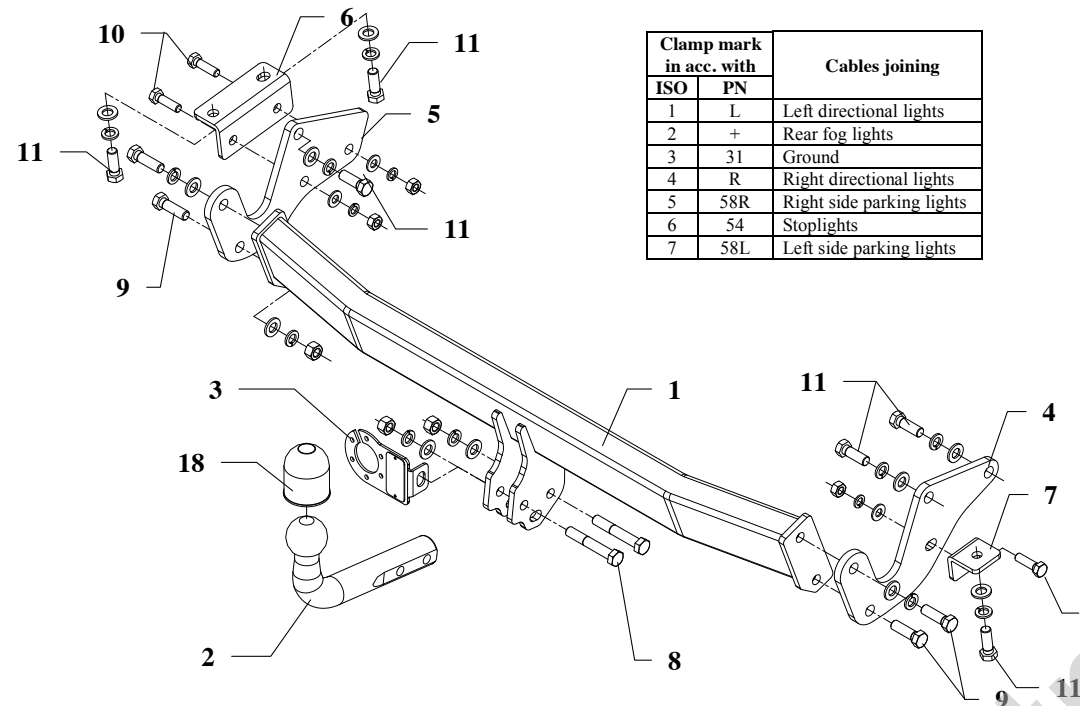

Clamp mark in acc. with		Cables joining
ISO	PN	
1	L	Left directional lights
2	+	Rear fog lights
3	31	Ground
4	R	Right directional lights
5	58R	Right side parking lights
6	54	Stoplights
7	58L	Left side parking lights

This towing hitch is designed to assembly in following cars: **TOYOTA PICNIC, 5 doors, VAN (XM1)**, produced since 10.1996 till 05.2001, catalogue no. **O54** and is prepared to tow trailers max total weight **1500 kg** and max vertical mass **60 kg**.

### From manufacturer

Thank you for buying our product. Their reliability has been confirmed in many tests. Reliability of towing hitch depends also on correct assembly and right operation. For this reasons we kindly ask to read carefully this instruction and apply to hints.

*The towing hitch should be install in points described by a car producer.*

Torque settings for nuts and bolts (8,8):

<b>M6</b> - 11 Nm	<b>M 8</b> - 25 Nm	<b>M 10</b> - 50 Nm
<b>M 12</b> - 87 Nm	<b>M 14</b> - 138 Nm	<b>M16</b> - 210 Nm

## The instruction of the assembly

1. Disassemble a rear bumper, spare wheel and original tow handles from the left and right side (not used any more).
2. Angle bar I (pos. 6) put underneath to left chassis member and fix loosely using bolts M12x1,25x35mm (pos. 11), next to inside of the chassis member put left bracket (pos. 5) and fix by one bolt M12x1,25x35mm (pos. 11) and two bolts M10x35mm (pos. 10) with angle bar (pos. 6)- loosely.
3. Angle bar II (pos. 7) put underneath to right chassis member and fix loosely using bolt M12x1,25x35mm (pos. 11), next to inside of the chassis member put right bracket (pos. 4) and fix by one bolt M12x1,25x35mm (pos. 11) and two bolts M10x35mm (pos. 10).
4. Between installed brackets put main bar of the towing hitch (pos. 1) and fix it by bolts M12x40mm (pos. 9)- see figure.
5. Tighten all bolts according to the torque shown in the table.
6. Reassemble bumper after cut out his fragments – see figure 2.
7. Fix tow-ball (pos. 2) and socket plate (pos. 3) by bolts M12x75mm (pos. 8) from accessories.
8. Connect electric wires of 7-poles socket according to the instruction of the car. (Recommend to make at authorized service station)
9. Complete paint layer damaged during installation.

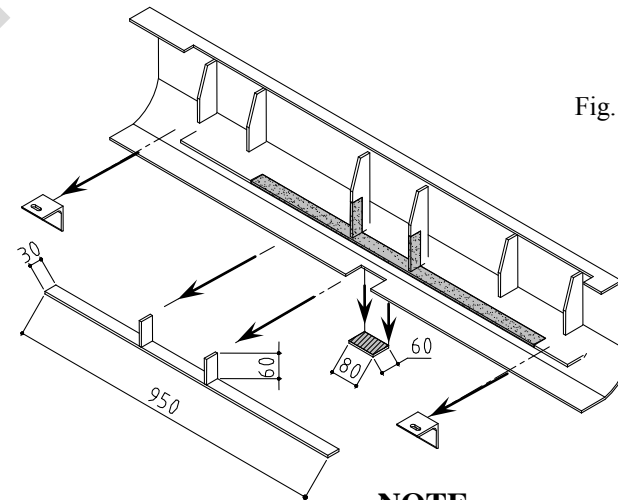

Fig. 2











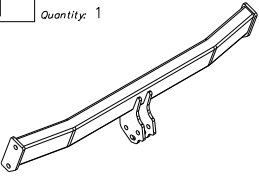





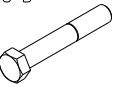

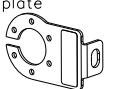
### NOTE

After install the towing hitch you should get adequate note in registration book (at authorised service station).The car should be equipped with:

- Indicators
- Tow mirrors

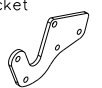
After 1000km check all bolts and nuts. The ball of towing hitch must be always kept clear and conserve with a grease.

## Towing hitch accessories:

Pos. 1 Name: Main bar Quantity: 1	Pos. 6 Name: Angle bar I Quantity: 1	Pos. 12 Name: Nut 8 B Quantity: 4 Dim.: M12
	Pos. 7 Name: Angle bar II Quantity: 1	Pos. 13 Name: Nut 8 B Quantity: 3 Dim.: M10
		
		
Pos. 2 Name: Tow ball Quantity: 1	Pos. 8 Name: Bolt 8,8 B Quantity: 2 Dim.: M12x75mm	Pos. 14 Name: Plain washer Quantity: 12 Dim.: Ø 13 mm
		
Pos. 3 Name: Socket plate Quantity: 1	Pos. 9 Name: Bolt 8,8 B Quantity: 4 Dim.: M12x40mm	Pos. 15 Name: Plain washer Quantity: 3 Dim.: Ø 10,5 mm
		
Pos. 4 Name: Right bracket Quantity: 1	Pos. 10 Name: Bolt 8,8 B Quantity: 3 Dim.: M10x35mm	Pos. 16 Name: Spring washer Quantity: 12 Dim.: Ø 12,2 mm
		
Pos. 5 Name: Left bracket Quantity: 1	Pos. 11 Name: Bolt 8,8 B Quantity: 6 Dim.: M12x1.25x35mm	Pos. 17 Name: Spring washer Quantity: 3 Dim.: Ø 10,2 mm
		
	Pos. 18 Name: Ball cover Quantity: 1	



**PPUH AUTO-HAK S.J.**

Produkcja Haków Holowniczych  
Henryk i Zbigniew Nejman  
76-200 SŁUPSK ul. Słoneczna 16K  
tel/fax (059) 8-414-414; 8-414-413  
E-mail: office@autohak.com.pl  
www. autohak.com.pl

## Towing hitch (without electrical set)

Class: **A50-X** Cat. no. **O54**

Designed for:

Manufacturer: **TOYOTA**

Model: **PICNIC**

Type: **5 doors, VAN (XM1)**

produced since 10.1996 till 05.2001

Technical data:

**D-value: 8,51 kN**

maximum trailer weight: **1500 kg**

maximum vertical cup load: **60 kg**

**Approval number according to Directive 94/20/EC: e20\*94/20\*0346\*00**

### Foreword

This towing hitch is designed according to rules of safety traffic regulations. The towing hitch is a safety component and must be installed only by qualified personnel. Any alteration or conversion to the towinh hitch is prohibited and would lead to cancellation of design certification. Remove insulating compound and underseal from vehicle (if present) in the area of the matting surfaces of the towing hitch.

The vehicle manufacturer's specifications regarding trailer load and max. vertical cup load are decisive for driving, and values for the towing hitch must not be exceeded.

*D-value formula:*

$$\frac{\text{Max trailer weight [kg]} \times \text{Max vehicle weight [kg]}}{\text{Max trailer weight [kg]} + \text{Max vehicle weight [kg]}} \times \frac{9,81}{1000} = D \text{ [kN]}$$