

PPUH AUTO-HAK Sp.J.

Henryk i Zbigniew Nejman
ul. Słoneczna 16K 76-200 SŁUPSK
POLAND











tel/fax +48 59 8 414 414; +48 59 8 414 413

e-mail: office@autohak.com.pl

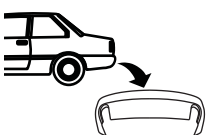
www.autohak.com.pl

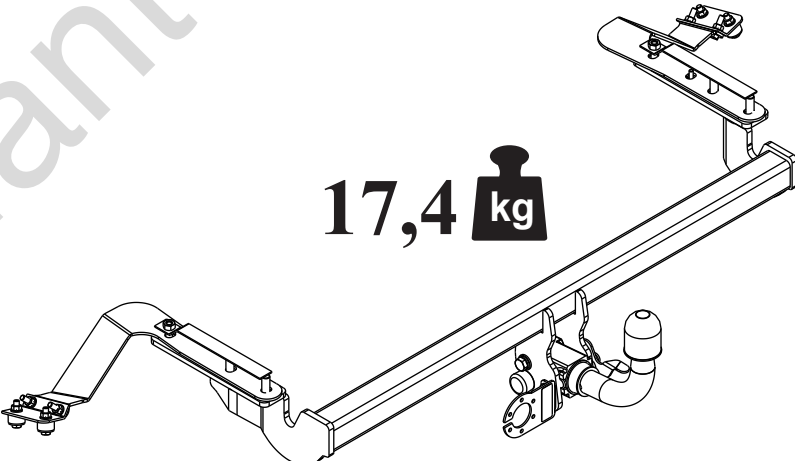

AUTO-HAK

	TOYOTA AVENSIS 4/5 D, (T25, T26)	Cat. no: O55A
	04.2003 → 12.2008	
e20	<u>e20*94/20*1146*01</u>	
D	8,6 kN	 2h
	R=1550 kg	 <input checked="" type="checkbox"/>
	S=75 kg	 <input type="checkbox"/>
 17,4 kg		
	M6 - 11 Nm M10 - 50 Nm M14 - 138 Nm	M8 - 25 Nm M12 - 87 Nm M16 - 210 Nm
 0 km →  1000 km		

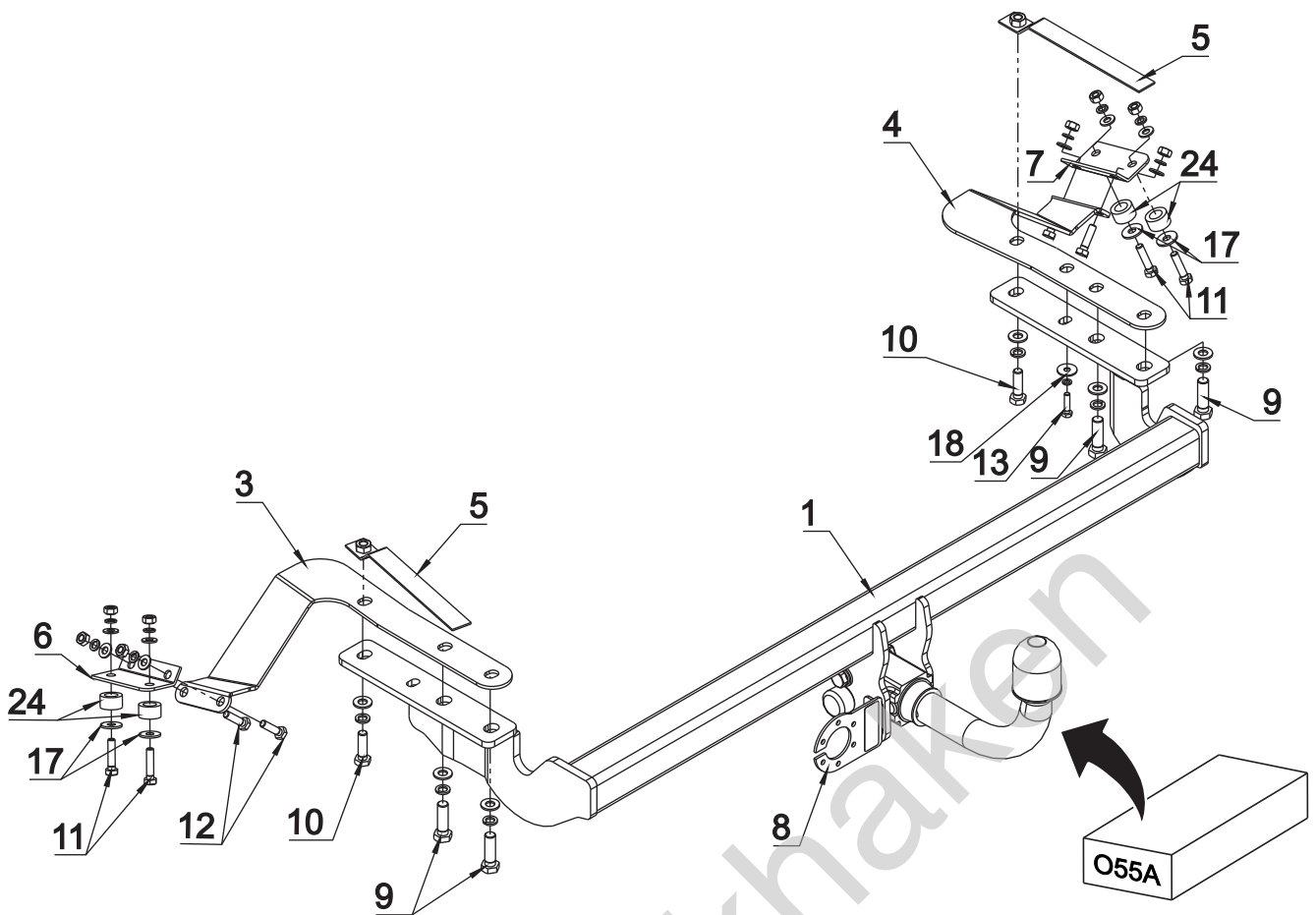

1		x1		9	M12x1,25x40	x4
				10	M10x35	x2
				11	M8x35	x4
				12	M8x30	x4
				13	M6x25	x1
2		x1		14	∅ 13	x4
				15	∅ 10.5	x2
				16	∅ 8.5	x8
				17	∅ 24x∅8.4x2 8 DIN 9021	x4
				18	∅ 18x∅6.4x1.6 6 DIN 9021	x1
				19	∅ 12.2	x4
					20	∅ 10.2
				21	∅ 8.2	x8
					22	∅ 6.2
				23	M8	x8
					24	
				∅25x15mm L=14mm		
8		x1				
				Art.nr-BL1055A		

