

PPUH AUTO-HAK Sp.J.

Henryk i Zbigniew Nejman
ul. Słoneczna 16K 76-200 SŁUPSK
POLAND

tel/fax +48 59 8 414 414; +48 59 8 414 413

e-mail: office@autohak.com.pl

www.autohak.com.pl



AUTO-HAK



TOYOTA VERSO S

(VAN), ~~1.4D-4D~~

03.2011 →

SUBARU TREZIA

04.2011 →

Cat. no:

O83A

e20

e20*94/20*1661*00



1h

D

5,84 kN



-



R=900 kg



-



S=50 kg

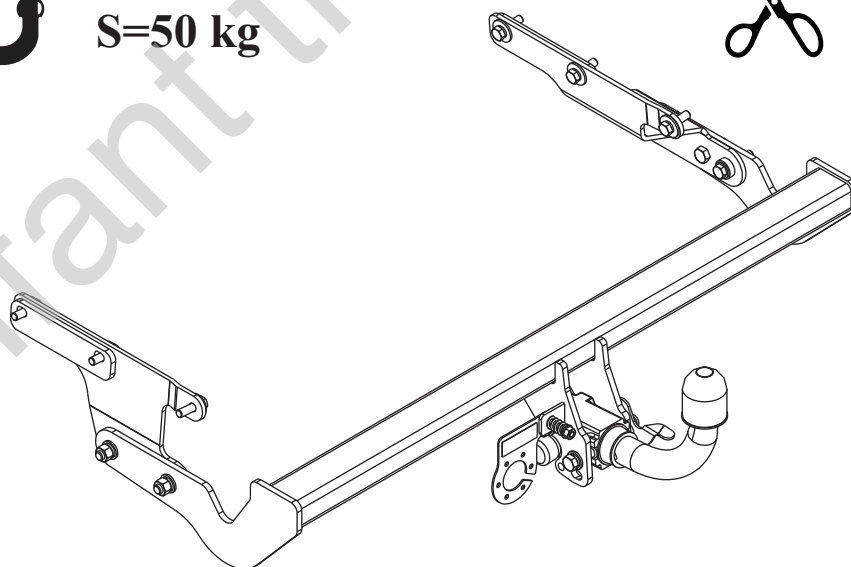

M6 - 11 Nm
M10 - 50 Nm
M14 - 138 Nm

M8 - 25 Nm
M12 - 87 Nm
M16 - 210 Nm









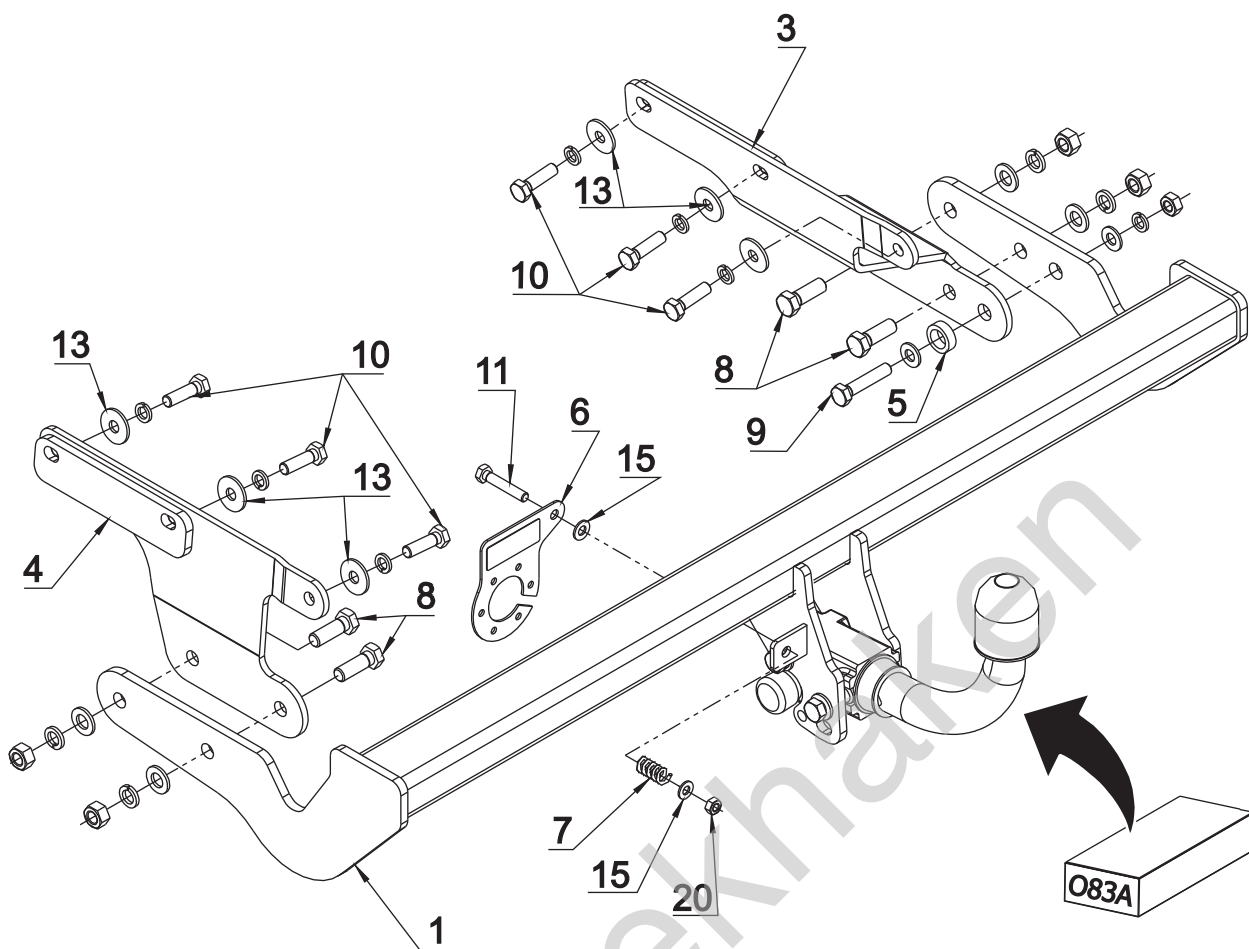

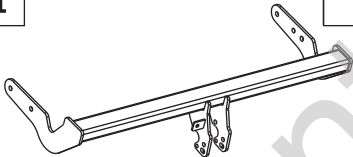

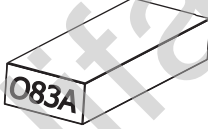



0 km →



1000 km



1		x1		8 M12x35	x4
2	 Art.nr-KL1O83A	x1		9 M10x50	x1
3		x1		10 M10x1.25x35	x6
4		x1		11 M8x45	x1
5	 Ø25x4mm L=8mm	x1		12 Ø 13	x4
6	 Art.nr-BL1O83A	x1		13 Ø 30xØ10.5x2.5 10 (DIN 9021)	x6
7		x1		14 Ø 10.5	x2
				15 Ø 8.4	x2
				16 Ø 12.2	x4
				17 Ø 10.2	x7
				18 M12	x4
				19 M10	x1
				20 M8	x1

