

PPUH AUTO-HAK Sp.J.

Henryk & Zbigniew Nejman
ul. Słoneczna 16K 76-200 SŁUPSK
POLAND

tel/fax +48 059 8-414-414; 8-414-413

e-mail: office@autohak.com.pl

www.autohak.com.pl



AUTO-HAK



**RENAULT MEGANE
KOMBI/GRANDTOUR**

Cat. no:

G89A



09.2016 →



E20-55R-01 4935



10,10 kN



R=2000 kg



S=80 kg



2h

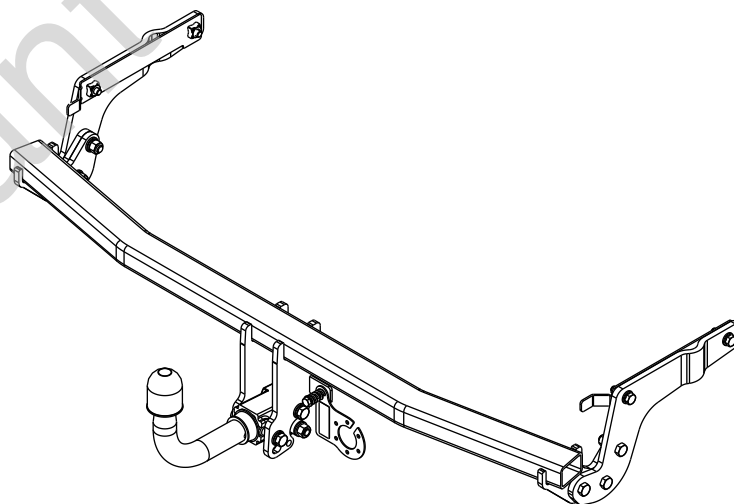

M6 - 8,5 Nm
M10 - 41 Nm
M14 - 112 Nm

M8 - 20 Nm
M12 - 70 Nm
M16 - 170 Nm









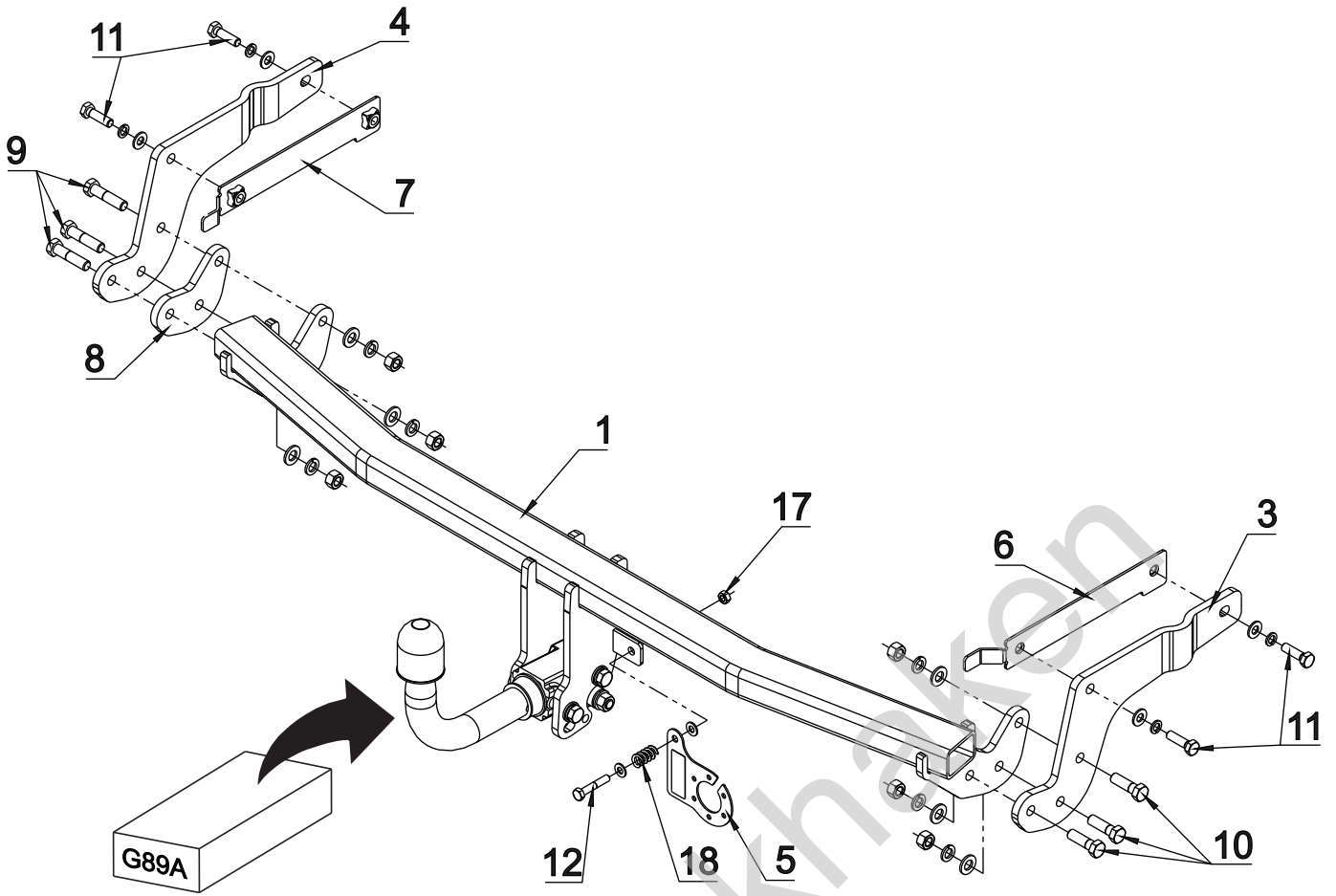

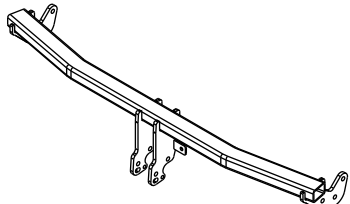

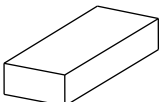
0 km →

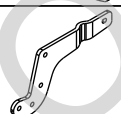
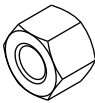
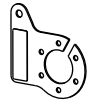
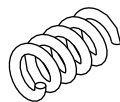
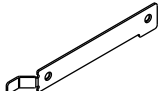

1000 km

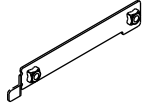

1		x1		9 M12x50	x3
				10 M12x40	x3
				11 M12x35	x4
				12 M8x45	x1
2	 Art.nr-KL1G89A	x1		13 ϕ 13	x10
				14 ϕ 8.5	x2
3		x1		15 ϕ 12.2	x10
4		x1		16 M12	x6
				17 M8	x1
5	 Art.nr-BL1G89A	x1	18		x1
6		x1	19		x1
7		x1			
8		x1			

